

General specifications	
Spa weight (dry)	553 Kg
Spa weight (filled)	3493 Kg
Package dimension	5000x2200x2350mm
Package weight	600 Kg

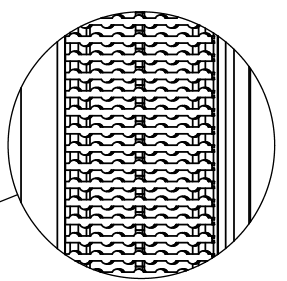

D (1 : 10)

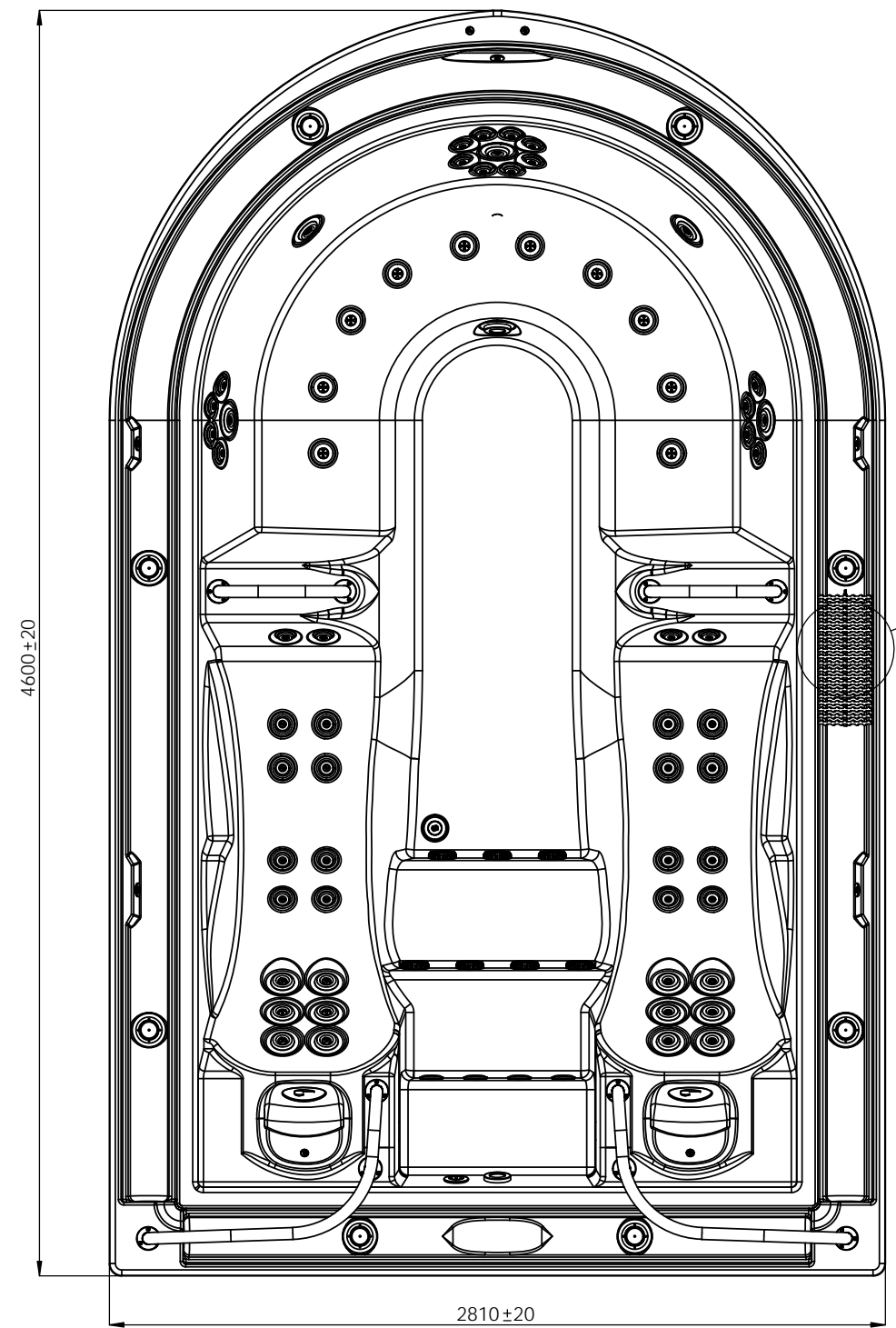
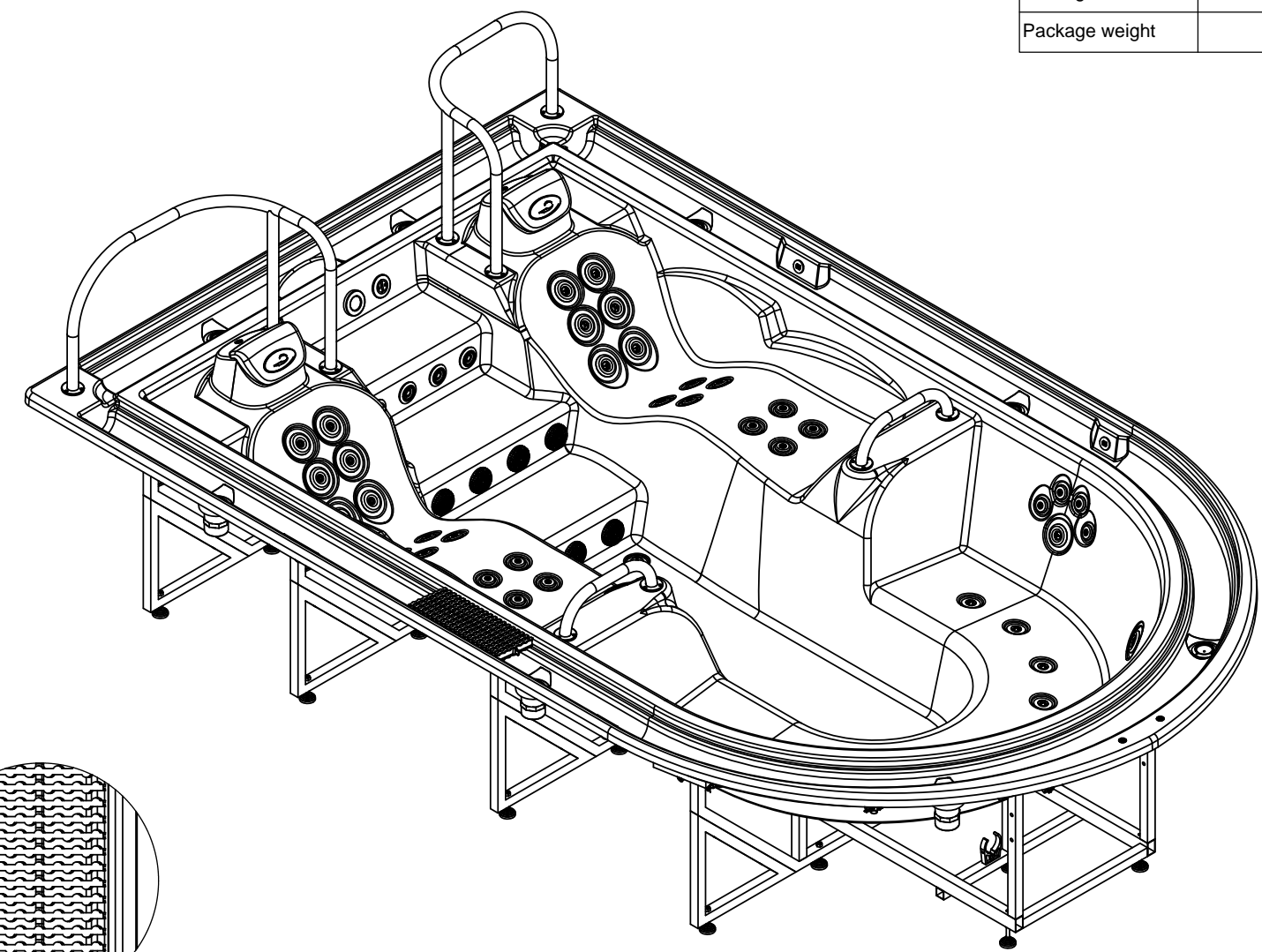
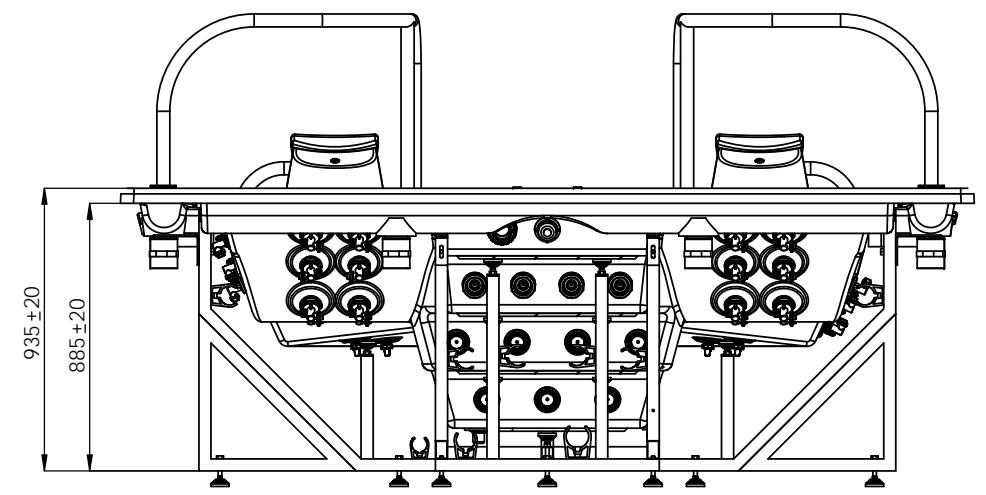
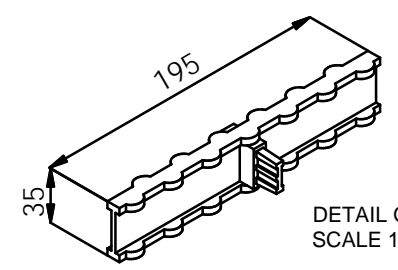

DETAIL GRID  
SCALE 1:4

VALID FROM 15/01/2016

According to our policy of continuous improvement, dimensions, features or components of this product can be partially or completely changed without prior notice. It's Customer responsibility to verify that this is the last version of the drawing

Change No.	Date	Name	Modification
06	18/02/2016	I.Pozo	Change light and drain
05	08/08/2014	I.Pozo	Change number grating
04	12/06/2014	I.Pozo	New spare template
03	26/05/2014	I.Pozo	New templates

Remarks Dimensions in mm. General Tolerances +/- 10mm			COMMERCIAL		
Drawn	22/01/2009	M.Baraut		Part Number	Rev.
Checked	22/01/2009	I.Nicolas		43638	06
Scale	1:25				
Sheet	1/3			General Tolerance DIN 7168 ISO 2768g	

↑ ↑  
HYDRAULIC CONNECTIONS ACCESS

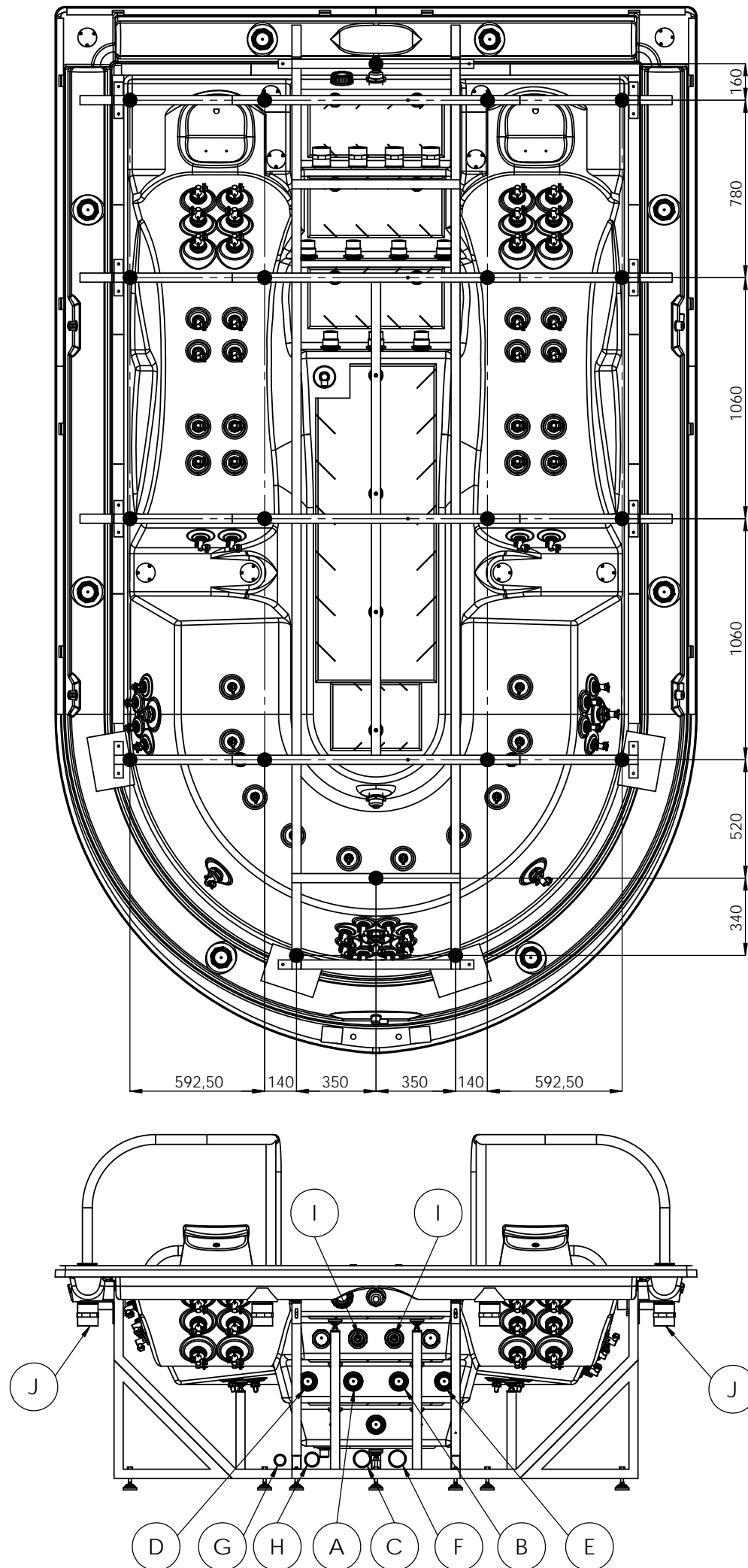

A	Suction-Water Massage Pump 1	Ø63 FEMALE SOCKET
B	Suction-Water Massage Pump 2	Ø63 FEMALE SOCKET
C	Suction-Water Massage Pump 3	Ø75 FEMALE SOCKET
D	Return-Water Massage Pump 1	Ø63 FEMALE SOCKET
E	Return-Water Massage Pump 2	Ø63 FEMALE SOCKET
F	Return-Water Massage Pump 3	Ø75 FEMALE SOCKET
G	Return-Air Massage	Ø50 FEMALE SOCKET
H	Suction/Return-Filtration Pump Bottom Spa	Ø63 FEMALE SOCKET
I	Return-Filtration Pump Inlets (2x)	Ø63 FEMALE SOCKET
J	Overflow Drains (8x)	Ø75 FEMALE SOCKET

VALID FROM 15/01/2016

**WARNING:**  
It's essential to keep a minimum clearance access of **700mm** all around.

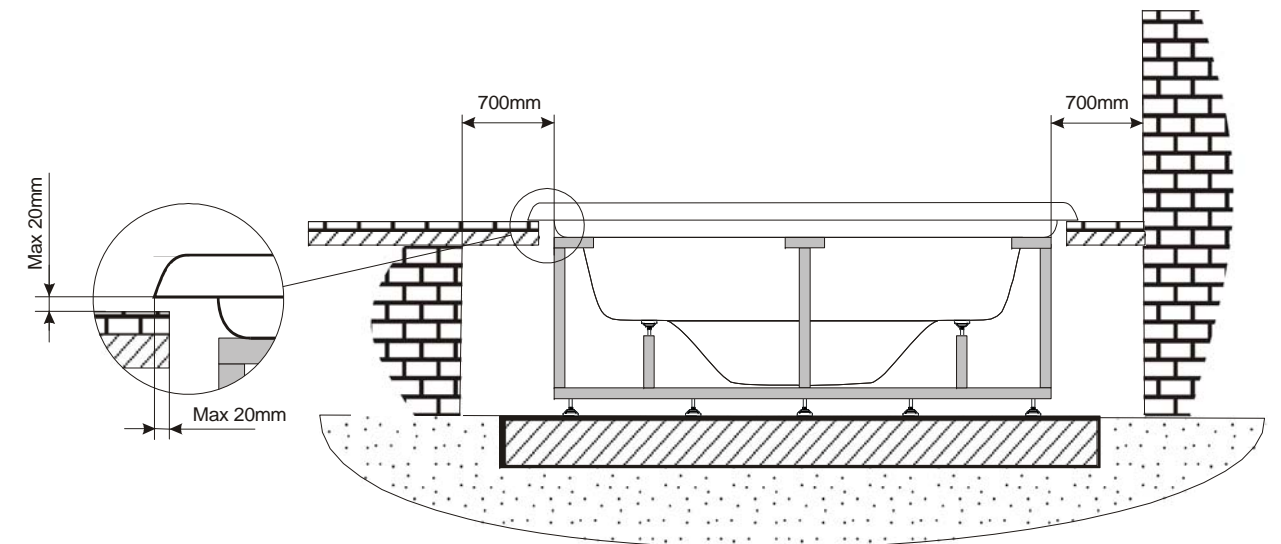

According to our policy of continuous improvement, dimensions, features or components of this product can be partially or completely changed without prior notice.  
It's Customer responsibility to verify that this is the last version of the drawing

Change No.	Date	Name	Modification
06	18/02/2016	I.Pozo	Change light and drain
05	08/08/2014	I.Pozo	Change number grating
04	12/06/2014	I.Pozo	New spare template
03	26/05/2014	I.Pozo	New templates

Remarks Dimensions in mm. General Tolerances +/- 10mm			COMMERCIAL			
Drawn	22/01/2009	M.Baraut	<b>IBERSPA</b>	Part Number	Rev.	First Angle Projection
Checked	22/01/2009	I.Nicolas		43638	06	
Scale	1:25		<b>IBERSPA</b>			
Sheet	2/3			General Tolerance DIN 7168 ISO 2768g		



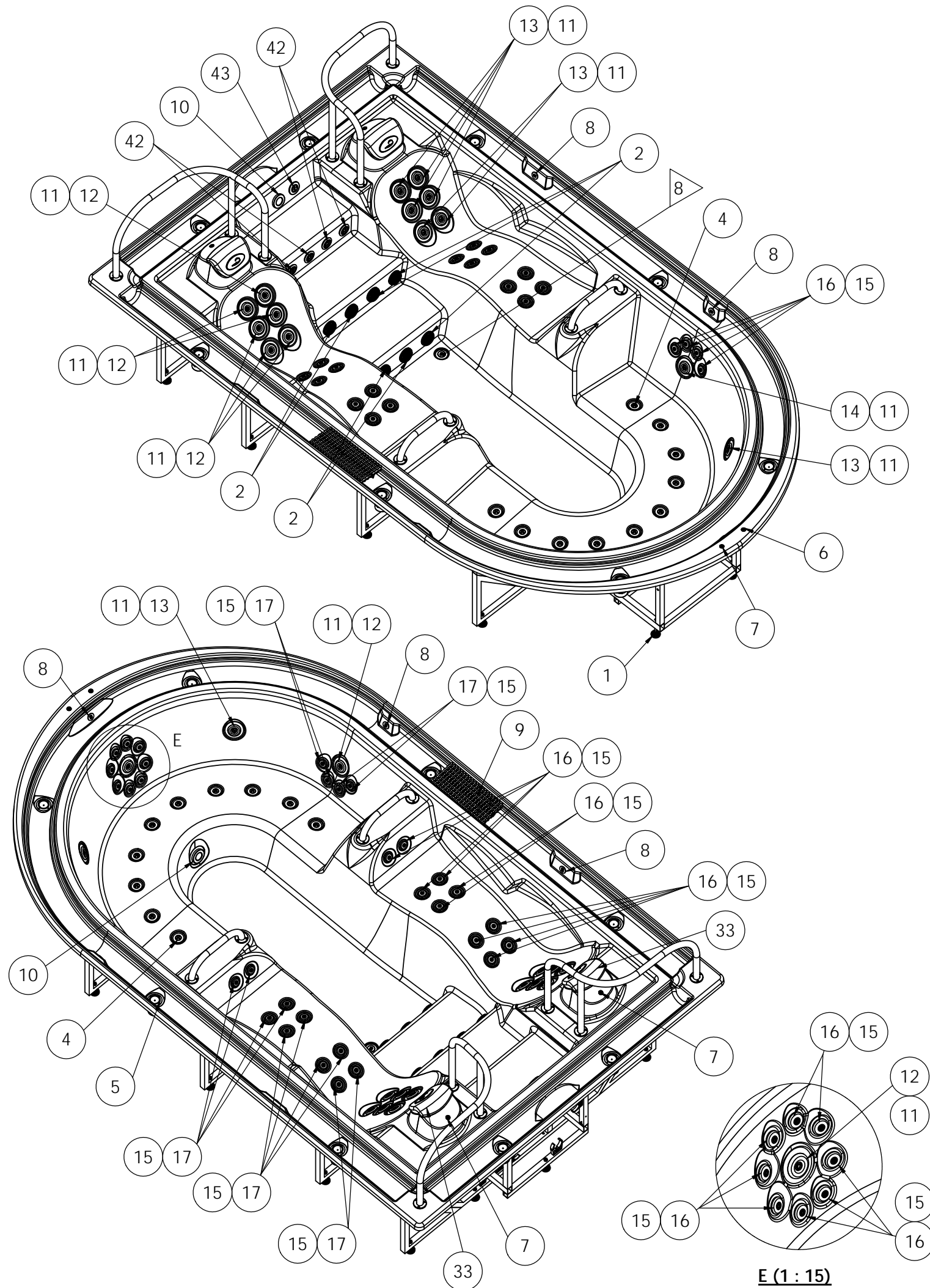

STAINLESS STEEL JETS + WHITE LIGHT			
Position Num.	Part Nº SPARE	Description SPARE	Quant.
1	303325R	SPA SUPPORT	20
2	RPOR0223	WHITE SPA DRAIN 2" ADAPTOR SOCKET D.50	7
4	REMP0046	WHITE-STAINLESS STEEL AIR NOZZLE	10
5	REMP0051	WHITE SPA DRAIN 2 1/2"	8
6	REMP0034	DIGITAL BUTTON IP68 ALUM. AIR	1
7	REMP0033	DIGITAL BUTTON IP68 ALUM. WATER	3
8	RROT0063	INTERNAL GREY DRAINPIPE	5
8	RPOR0003	GREY DRAIN SET - BODY+COVER+ASSEMBLY	1
9	REMP0032	DIN CURVED GRATING WIDTH 195 mm	636
10	RCOM0071	HIGH INTENSITY WHITE LED SPOTLIGHTS + STAINLESS STEEL ESCUTCHEON SPOTLIGHT	2
11	RPOR0236	JET BODY SET RD 3"	17
12	RPOR0231	FRONTAL JET 3" STAINLESS STEEL DIRECTIONAL	8
13	RPOR0232	FRONTAL JET 3" STAINLESS STEEL 1 JET ROTO	8
14	RPOR0233	FRONTAL JET 3" STAINLESS STEEL TWIN ROTO	1
15	RPOR0235	JET BODY SET RD 2"	36
16	RPOR0230	FRONTAL JET 2" STAINLESS STEEL DIRECTIONAL	22
17	RPOR0260	JET TWIN ROTO 2" INOX	14
33	RPOR0094	BIG HEADREST - PACIFIC-ANTARTIC-EVOLUTION	2
42	REMP0010	PRESSURE NOZZLE	4
43	REMP0052	VACUUM POINT	1

WHITE JETS + WHITE LIGHT			
Position Num.	Part Nº SPARE	Description SPARE	Quant.
1	303325R	SPA SUPPORT	20
2	RPOR0223	WHITE SPA DRAIN 2" ADAPTOR SOCKET D.50	7
4	REMP0029	KIT STORM AIR NOZZLE	10
5	REMP0051	WHITE SPA DRAIN 2 1/2"	8
6	REMP0034	DIGITAL BUTTON IP68 ALUM. AIR	1
7	REMP0033	DIGITAL BUTTON IP68 ALUM. WATER	3
8	RROT0063	INTERNAL GREY DRAINPIPE	5
8	RPOR0003	GREY DRAIN SET - BODY+COVER+ASSEMBLY	1
9	REMP0032	DIN CURVED GRATING WIDTH 195 mm	636
10	RCOM0070	HIGH INTENSITY WHITE LED SPOTLIGHTS + WHITE ESCUTCHEON SPOTLIGHT	2
11	RPOR0236	JET BODY SET RD 3"	17
12	REMP0058	FRONTAL JET DIRECCIONAL 3"	8
13	REMP0059	FRONTAL JET ROT 1 CHORRO 3"	8
14	REMP0060	FRONTAL JET ROT 2 CHORRO 3"	1
15	RPOR0235	JET BODY SET RD 2"	36
16	REMP0056	JET DIRECTIONAL 2" WHITE	22
17	REMP0057	JET 2" TWIN ROTO WHITE	14
33	RPOR0094	BIG HEADREST - PACIFIC-ANTARTIC-EVOLUTION	2
42	REMP0010	PRESSURE NOZZLE	4
43	REMP0052	VACUUM POINT	1

STAINLESS STEEL JETS + COLOUR LIGHT			
Position Num.	Part Nº SPARE	Description SPARE	Quant.
1	303325R	SPA SUPPORT	20
2	RPOR0223	WHITE SPA DRAIN 2" ADAPTOR SOCKET D.50	7
4	REMP0046	WHITE-STAINLESS STEEL AIR NOZZLE	10
5	REMP0051	WHITE SPA DRAIN 2 1/2"	8
6	REMP0034	DIGITAL BUTTON IP68 ALUM. AIR	1
7	REMP0033	DIGITAL BUTTON IP68 ALUM. WATER	3
8	RROT0063	INTERNAL GREY DRAINPIPE	5
8	RPOR0003	GREY DRAIN SET - BODY+COVER+ASSEMBLY	1
9	REMP0032	DIN CURVED GRATING WIDTH 195 mm	636
10	RCOM0063	HIGH INTENSITY COLOURS LED SPOTLIGHTS + STEEL ESCUTCHEON SPOTLIGHT	2
11	RPOR0236	JET BODY SET RD 3"	17
12	RPOR0231	FRONTAL JET 3" STAINLESS STEEL DIRECTIONAL	8
13	RPOR0232	FRONTAL JET 3" STAINLESS STEEL 1 JET ROTO	8
14	RPOR0233	FRONTAL JET 3" STAINLESS STEEL TWIN ROTO	1
15	RPOR0235	JET BODY SET RD 2"	36
16	RPOR0230	FRONTAL JET 2" STAINLESS STEEL DIRECTIONAL	22
17	RPOR0260	JET TWIN ROTO 2" INOX	14
33	RPOR0094	BIG HEADREST - PACIFIC-ANTARTIC-EVOLUTION	2
42	REMP0010	PRESSURE NOZZLE	4
43	REMP0052	VACUUM POINT	1

WHITE JETS + COLOUR LIGHT			
Position Num.	Part Nº SPARE	Description SPARE	Quant.
1	303325R	SPA SUPPORT	20
2	RPOR0223	WHITE SPA DRAIN 2" ADAPTOR SOCKET D.50	7
4	REMP0029	KIT STORM AIR NOZZLE	10
5	REMP0051	WHITE SPA DRAIN 2 1/2"	8
6	REMP0034	DIGITAL BUTTON IP68 ALUM. AIR	1
7	REMP0033	DIGITAL BUTTON IP68 ALUM. WATER	3
8	RROT0063	INTERNAL GREY DRAINPIPE	5
8	RPOR0003	GREY DRAIN SET - BODY+COVER+ASSEMBLY	1
9	REMP0032	DIN CURVED GRATING WIDTH 195 mm	636
10	RCOM0061	HIGH INTENSITY COLOURS LED SPOTLIGHTS + WITHE ESCUTCHEON SPOTLIGHT	2
11	RPOR0236	JET BODY SET RD 3"	17
12	REMP0058	FRONTAL JET DIRECCIONAL 3"	8
13	REMP0059	FRONTAL JET ROT 1 CHORRO 3"	8
14	REMP0060	FRONTAL JET ROT 2 CHORRO 3"	1
15	RPOR0235	JET BODY SET RD 2"	36
16	REMP0056	JET DIRECTIONAL 2" WHITE	22
17	REMP0057	JET 2" TWIN ROTO WHITE	14
33	RPOR0094	BIG HEADREST - PACIFIC-ANTARTIC-EVOLUTION	2
42	REMP0010	PRESSURE NOZZLE	4
43	REMP0052	VACUUM POINT	1

VALID FROM 15/01/2016

According to our policy of continuous improvement, dimensions, features or components of this product can be partially or completely changed without prior notice. It's Customer responsibility to verify that this is the last version of the drawing

Change No.	Date	Name	Modification
06	18/02/2016	I.Pozo	Change light and drain
05	08/08/2014	I.Pozo	Change number grating
04	12/06/2014	I.Pozo	New spare template
03	26/05/2014	I.Pozo	New templates

Remarks Dimensions in mm. General Tolerances +/- 10mm			<b>SPARE DRAWING</b>				
Drawn	22/01/2009	M.Baraut					
Checked	22/01/2009	I.Nicolas	<b>IBERSPA</b>		Part Number	Rev.	First Angle Projection
Scale 1:30	General Tolerance				43638	06	
Sheet 3/3	DIN 7168 ISO 2768g						