

According to our policy of continuous improvement, dimensions, features or components of this product can be partially or completely changed without prior notice. It's Customer responsibility to verify that this is the last version of the drawing

Property of IBERSPA S.L. Avda. Pla d'Urgell 2-8 25200 Cervera, Spain. Don't use without permission. Keep this information confidential and use it solely for the permitted purpose.

**CONTROL COMPONENTS**

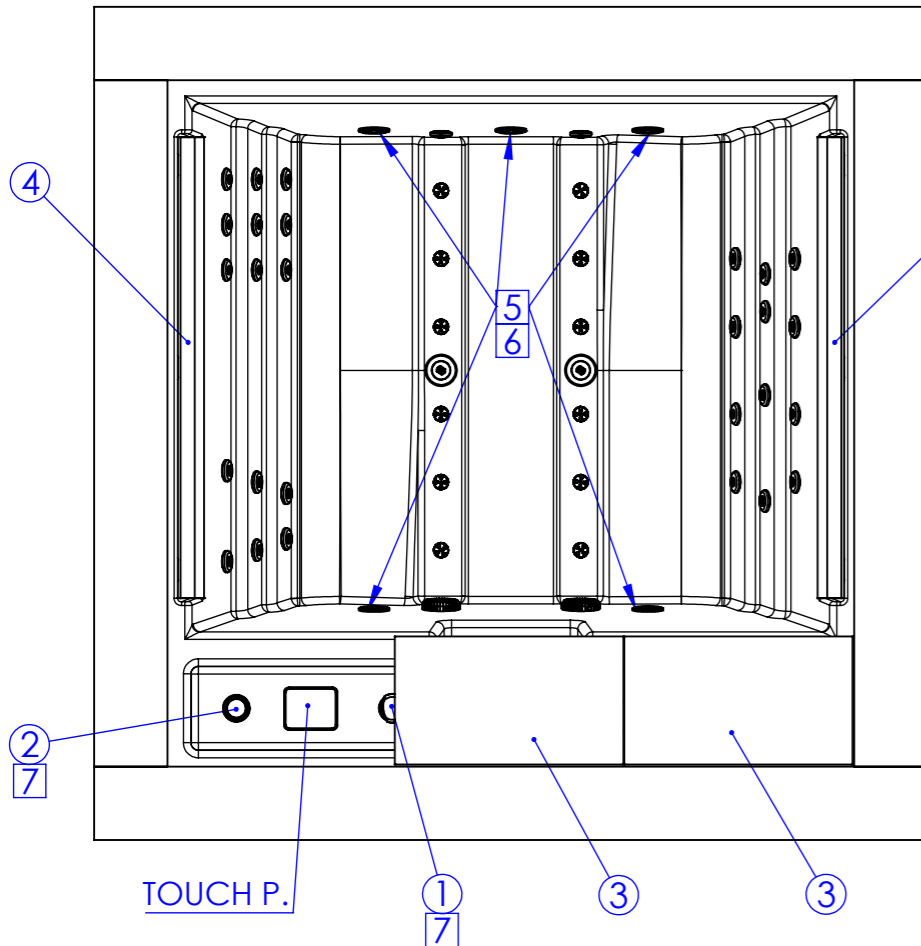

**PILLOWS**

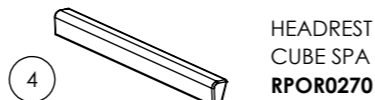
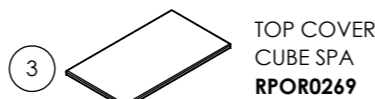

**MASSAGE COMPONENTS**

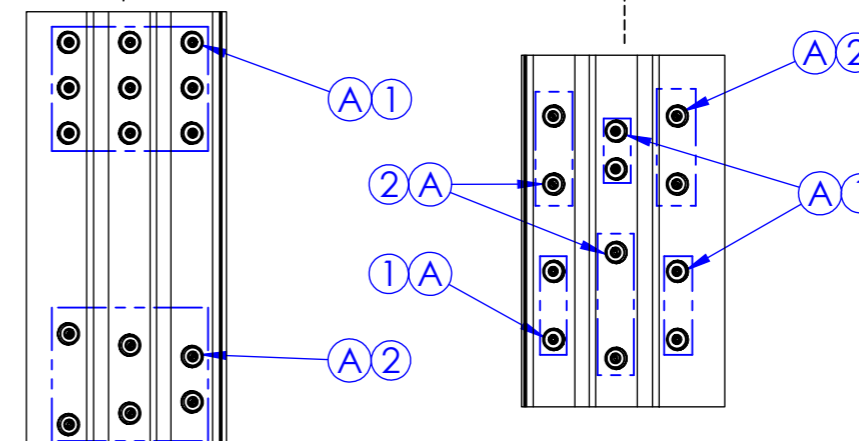
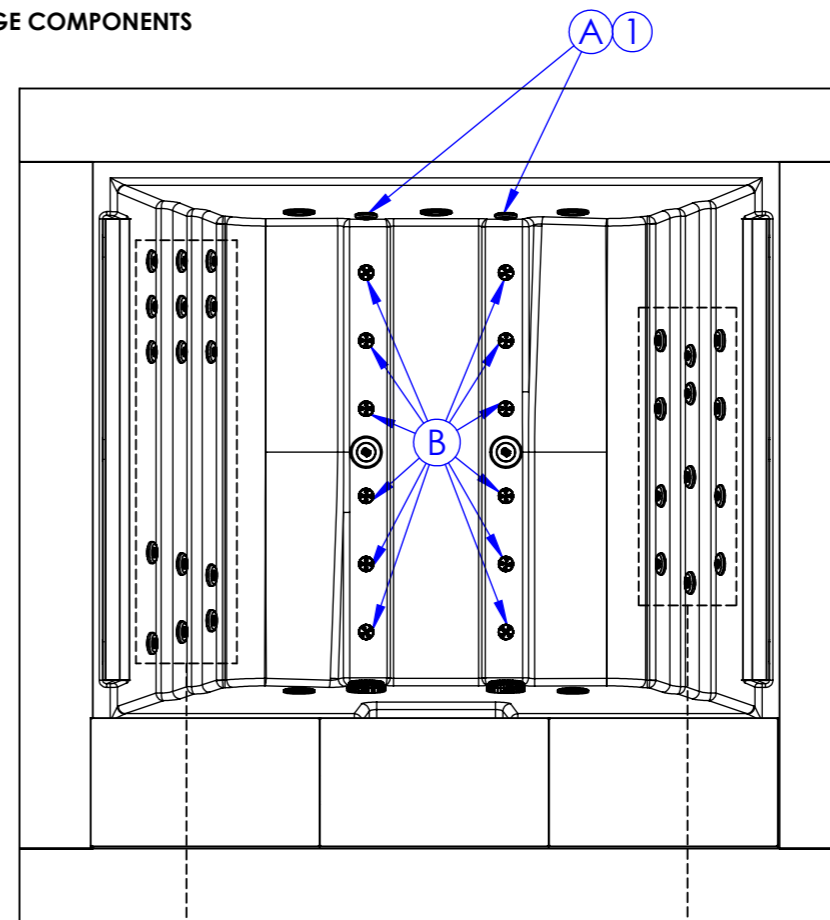

**LIGHT COMPONENTS**

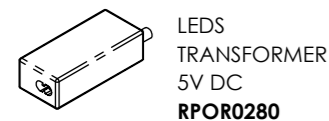
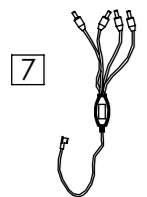

**CONTROL PANELS**



**HEATER**

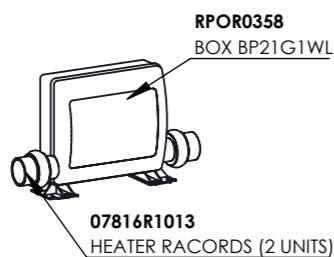

- RPOR0101 - TEMPERATURE PROBES GS I GL (x2)
- RPOR0105 - HEATER 3KW GS I GL
- RPOR0358-A - DIGITAL PANEL BP21G1WL
- RPOR0330 - EXPANDER BOARD KIT FOR SISTEM BP21G1WL
- RPOR0358-B - LEVEL SENSOR

**PUMPS**

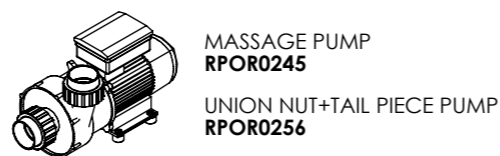

**COVER 62020**

**FILTRATION**

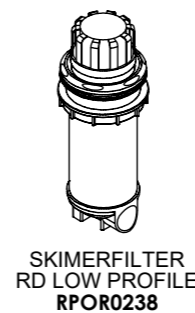

**DESINFECTION**

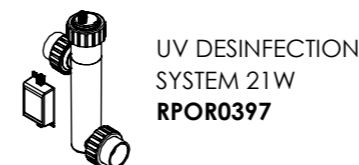

**AUDIO**

Option 4.1



**OTHER COMPONENTS**

