

'16
NOVEDAD
NEW

CARACTERÍSTICAS TÉCNICAS TECHNICAL CHARACTERISTICS



- ▼ Proyector LED circular de alta resistencia, fabricado en acero inoxidable. Ideal para iluminación de fuentes ornamentales y surtidores, en los que el proyector rodea la tobera.
Proyector de alta potencia para la iluminación completa del surtidor. Se suministra con rosca interior de 1 ½" y conexión para el cableado.

Circular type LED projector, high resistance, and made of stainless steel. Ideal RGB light for ornamental fountains and jets, in which the projector surrounds the nozzle.

High-power projector for full lighting supply of the jet. It comes with an internal thread of 1 ½" and wire connections.

CIRCULAR LED S RGB+W - DMX

Código / Code: 66590

Lúmens	902 lm	<i>Lumens</i>	902 lm
Potencia	30 W	<i>Power</i>	30 W
Eficiencia	27 lm/w	<i>Efficiency</i>	27 lm/w
Ópticas	Narrow 18º	Optical	Narrow 18º
	Medium 24º		Medium 24º
	Wide 32º		Wide 32º
Tensión Nominal	24 VDC	<i>Nominal Voltage</i>	24 VDC
Vida útil	L70 - 50.000h	<i>Life Span</i>	L70 - 50.000h
Colores	RGBW-DMX	<i>Colour</i>	RGBW-DMX
Cable de conexión	2 x 1mm2	<i>Connection cable</i>	2 x 1mm2





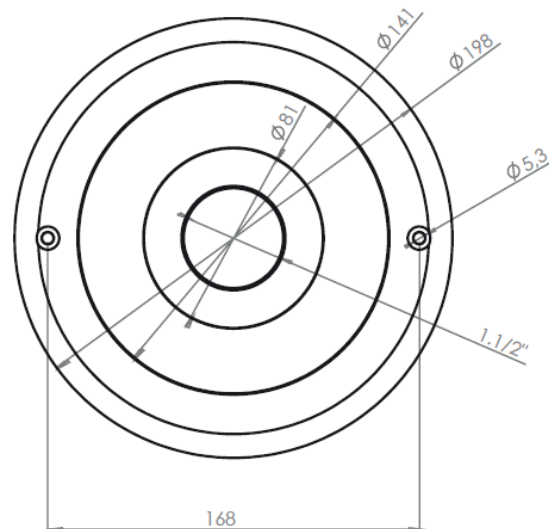
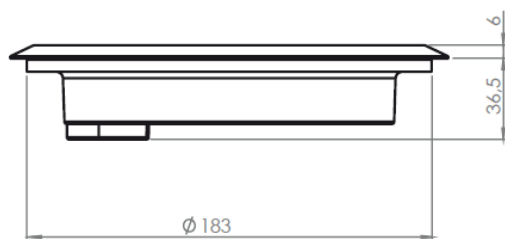

DIMENSIONES DIMENSIONS

Código / Code: 66590



EJEMPLOS EXAMPLES



Luz / Light	Embellecedor/Face plate	Óptica / Optic	Opción - Option	Módulos de control - Control modules
Color Código/Code	Material/Material	Código/Code		Código Denominación / Description
 M Multicolor /Multicolour	I Acero Inox. Stainless Steel	N Narrow Narrow	DMX	66594 DMX Driver
 R Rojo /Red		M MediumMedium		66595 DMX Driver EPS
 G Verde /Green		W Wide Wide		66596 ONDMX Controller
 B Azul /Blue				66597 ONDMX Pro Controller
 W Blanco frío /Cool white				
 NW Blanco neutro /Neutral white				
 WW Blanco cálido /Warm white				