

General specifications	
Spa weight (dry)	553 Kg
Spa weight (filled)	3493 Kg
Package dimension	5000x2200x2350mm
Package weight	600 Kg

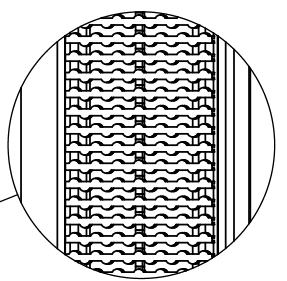

D (1 : 10)

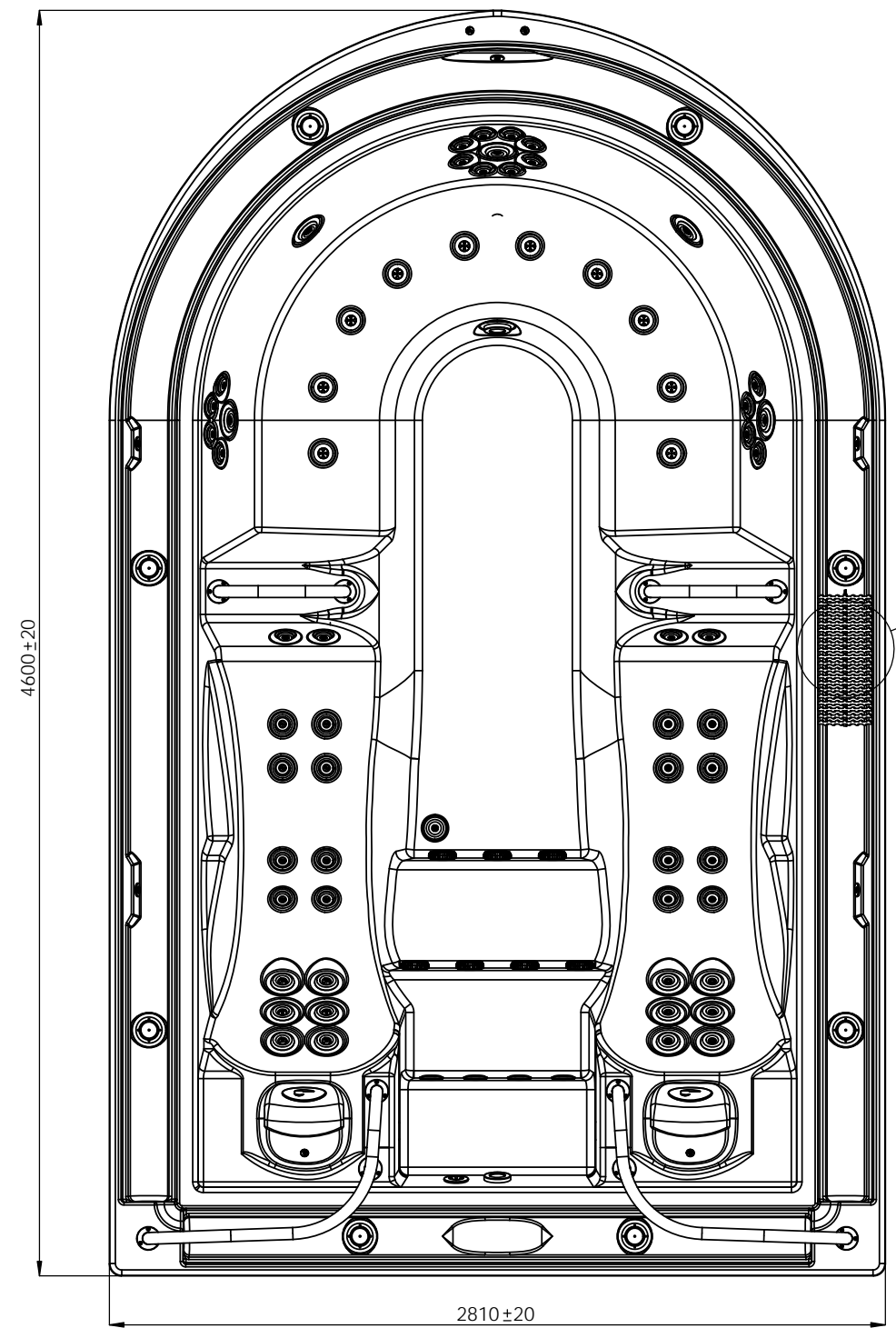
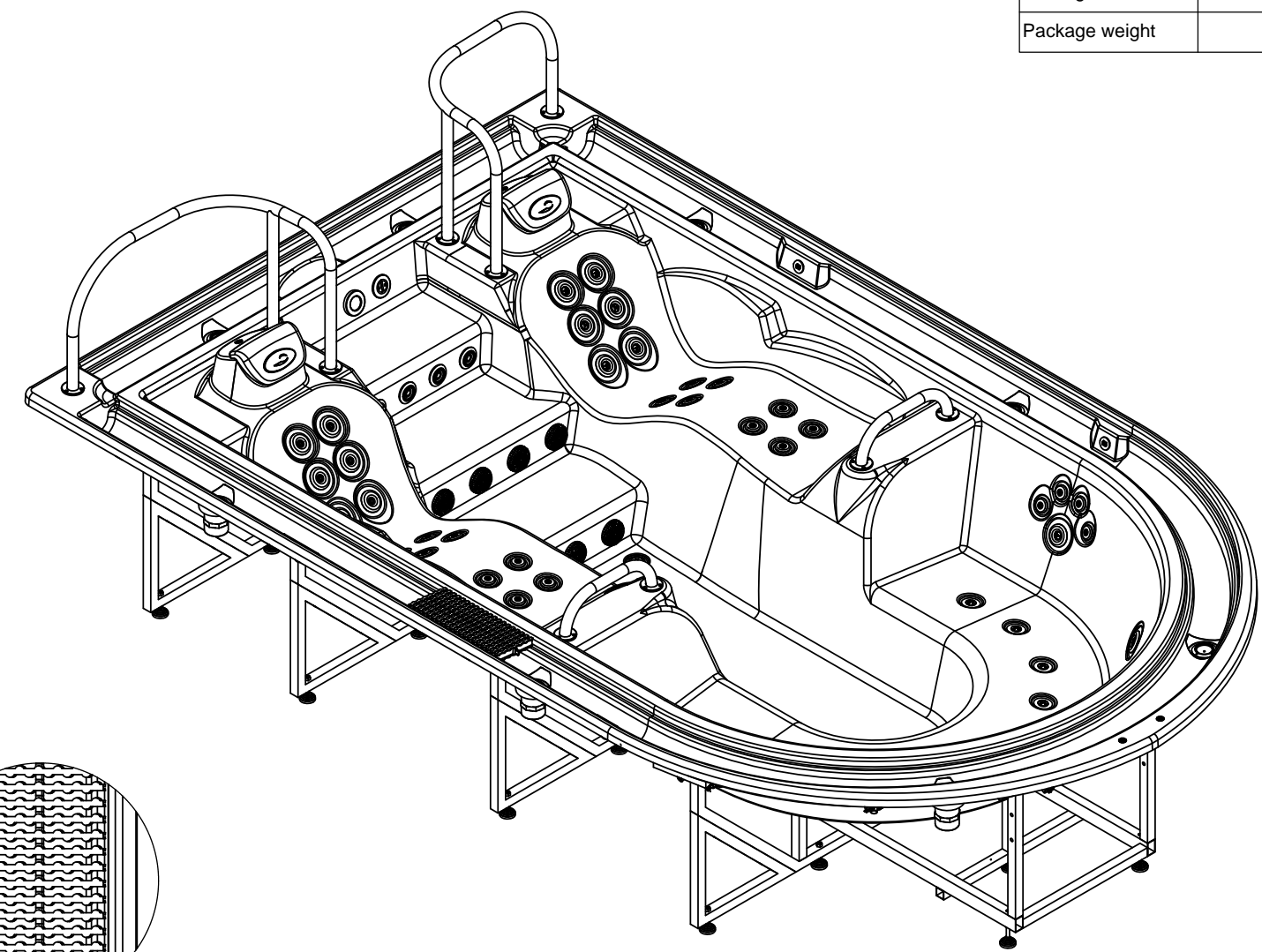
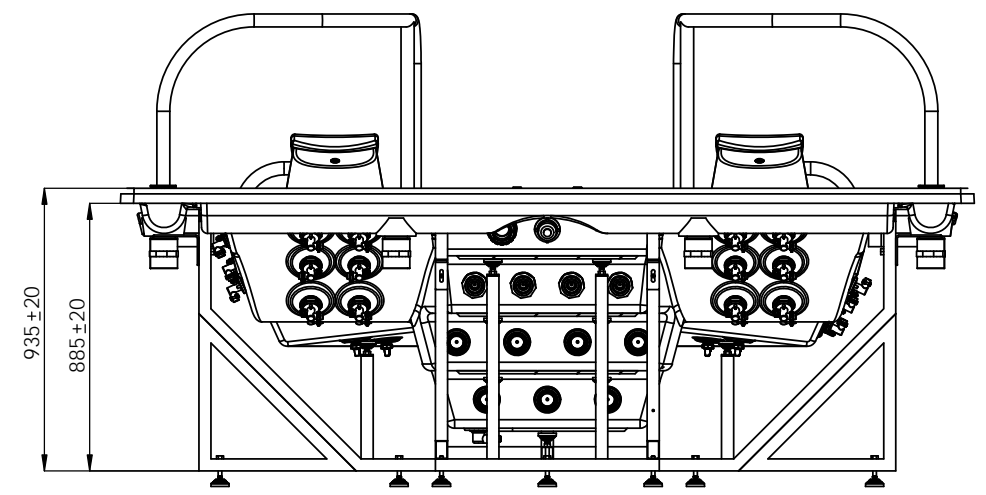
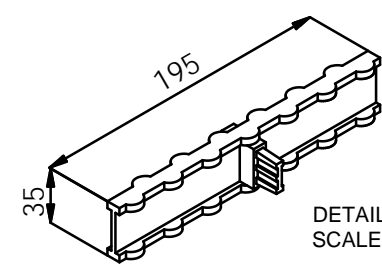

DETAIL GRID  
SCALE 1:4

According to our policy of continuous improvement, dimensions, features or components of this product can be partially or completely changed without prior notice. It's Customer responsibility to verify that this is the last version of the drawing

Change No.	Date	Name	Modification
05	08/08/2014	I.Pozo	Change number grating
04	12/06/2014	I.Pozo	New spare template
03	26/05/2014	I.Pozo	New templates
02	04/05/2011	F.Gómez	New electrical box, buttons and water level system
00	22/01/2009	M.Baraut	Drawing creation

Remarks Dimensions in mm. General Tolerances +/- 10mm			COMMERCIAL			
Drawn	22/01/2009	M.Baraut		Part Number <b>43638</b>	Rev. <b>05</b>	First Angle Projection 
Checked	22/01/2009	I.Nicolas				
Scale 1:25	General Tolerance DIN 7168 ISO 2768g					
Sheet 1/3						

↑ ↑  
HYDRAULIC CONNECTIONS ACCESS

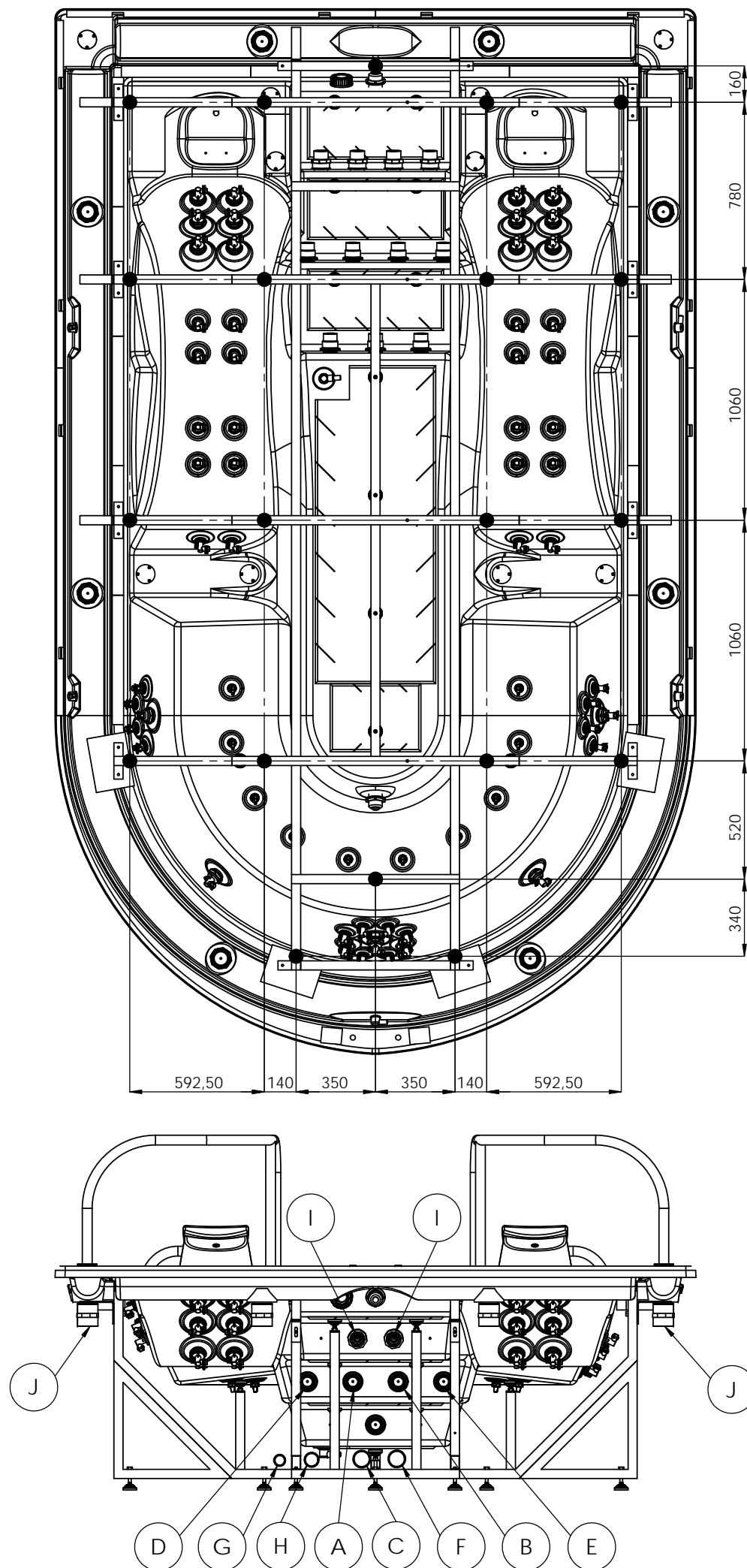

A	Suction-Water Massage Pump 1	Ø63 FEMALE SOCKET
B	Suction-Water Massage Pump 2	Ø63 FEMALE SOCKET
C	Suction-Water Massage Pump 3	Ø75 FEMALE SOCKET
D	Return-Water Massage Pump 1	Ø63 FEMALE SOCKET
E	Return-Water Massage Pump 2	Ø63 FEMALE SOCKET
F	Return-Water Massage Pump 3	Ø75 FEMALE SOCKET
G	Return-Air Massage	Ø50 FEMALE SOCKET
H	Suction/Return-Filtration Pump Bottom Spa	Ø63 FEMALE SOCKET
I	Return-Filtration Pump Inlets (2x)	Ø63 FEMALE SOCKET
J	Overflow Drains (8x)	Ø75 FEMALE SOCKET

**WARNING:**  
It's essential to keep a minimum clearance access of **700mm** all around.

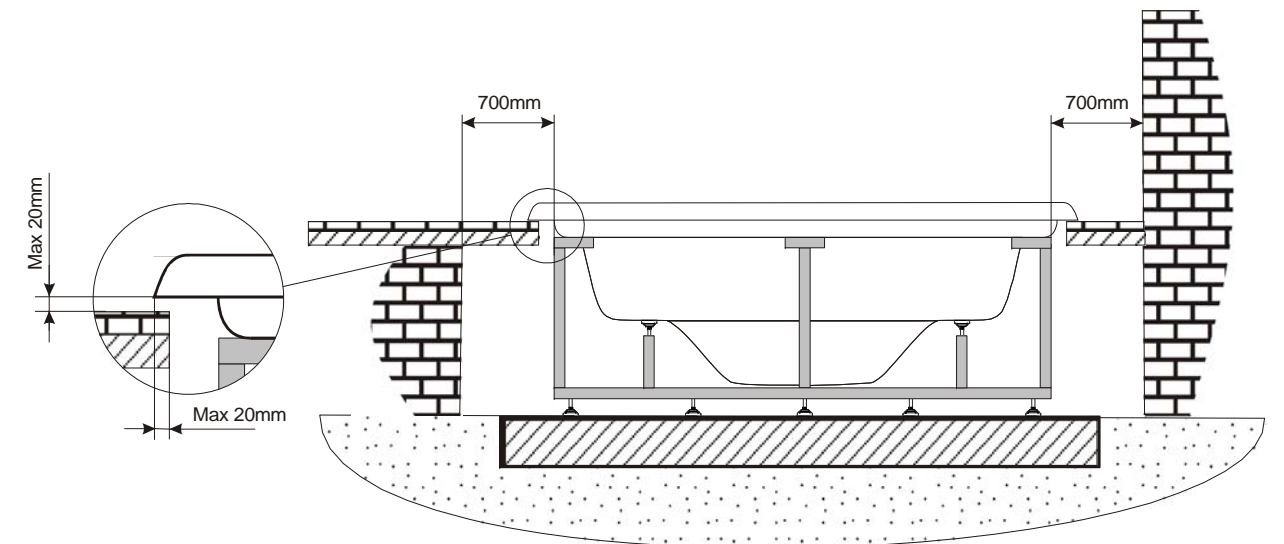

According to our policy of continuous improvement, dimensions, features or components of this product can be partially or completely changed without prior notice.  
It's Customer responsibility to verify that this is the last version of the drawing

Change No.	Date	Name	Modification
05	08/08/2014	I.Pozo	Change number grating
04	12/06/2014	I.Pozo	New spare template
03	26/05/2014	I.Pozo	New templates
02	04/05/2011	F.Gómez	New electrical box, buttons and water level system
00	22/01/2009	M.Baraut	Drawing creation

Remarks Dimensions in mm. General Tolerances +/- 10mm			<b>COMMERCIAL</b>			
Drawn	22/01/2009	M.Baraut		Part Number <b>43638</b>	Rev. <b>05</b>	First Angle Projection 
Checked	22/01/2009	I.Nicolas				
Scale	1:25		General Tolerance DIN 7168 ISO 2768g			
Sheet	2/3		Property of IBERSPA S.L. Avda. Pla d'Urgell 2-8 25200 Cervera, Spain. Don't use without permission. Keep this information confidential and use it solely for the permitted purpose.			

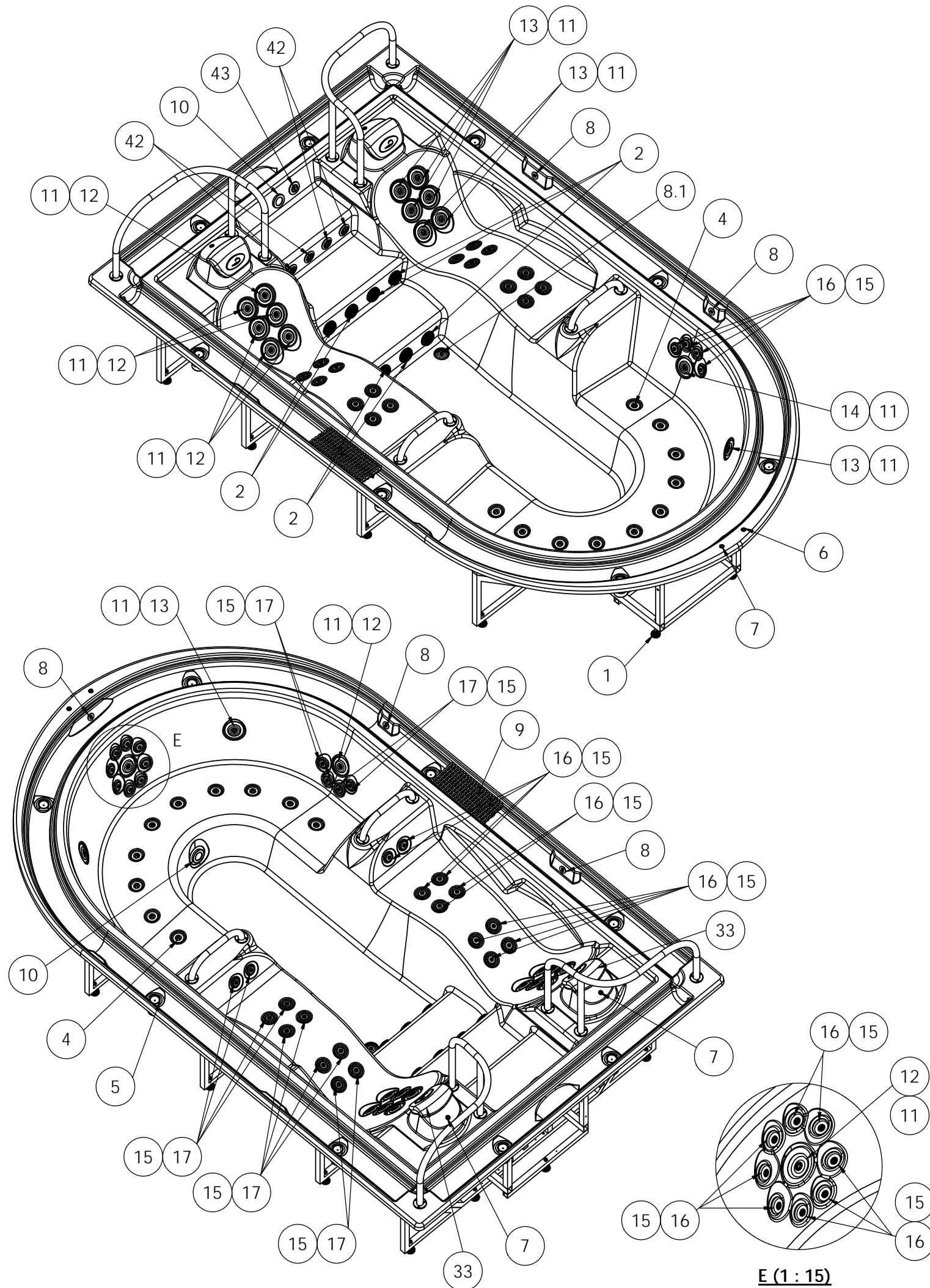

STAINLESS STEEL JETS + WHITE LIGHT			
Position Num.	Part Nº SPARE	Description SPARE	Quant.
1	303325R	SPA SUPPORT	33
2	RPOR0223	WHITE SPA DRAIN 2" ADAPTOR SOCKET D.50	7
4	REMP0046	WHITE-STAINLESS STEEL AIR NOZZLE	10
5	REMP0051	WHITE SPA DRAIN 2 1/2"	8
6	REMP0034	DIGITAL BUTTON IP68 ALUM. AIR	1
7	REMP0033	DIGITAL BUTTON IP68 ALUM. WATER	3
8	RROT0063	INTERNAL GREY DRAINPIPE	5
8.1	RPOR0001	WHITE DRAIN SET 1/2"	1
9	REMP0032	DIN CURVED GRATING WIDTH 195 mm	636
10	RPOR0024	LIGHT SPAS SI800	2
11	RPOR0236	JET BODY SET RD 3"	17
12	RPOR0231	FRONTAL JET 3" STAINLESS STEEL DIRECTIONAL	8
13	RPOR0232	FRONTAL JET 3" STAINLESS STEEL 1 JET ROTO	8
14	RPOR0233	FRONTAL JET 3" STAINLESS STEEL TWIN ROTO	1
15	RPOR0235	JET BODY SET RD 2"	36
16	RPOR0230	FRONTAL JET 2" STAINLESS STEEL DIRECTIONAL	22
17	RPOR0260	JET TWIN ROTO 2" INOX	14
33	RPOR0094	BIG HEADREST - PACIFIC-ANTARTIC-EVOLUTION	2
43	REMP0052	VACUUM POINT	1
42	REMP0010	PRESSURE NOZZLE	4

WHITE JETS + WHITE LIGHT			
Position Num.	Part Nº SPARE	Description SPARE	Quant.
1	303325R	SPA SUPPORT	33
2	RPOR0223	WHITE SPA DRAIN 2" ADAPTOR SOCKET D.50	7
4	REMP0029	KIT STORM AIR NOZZLE	10
5	REMP0051	WHITE SPA DRAIN 2 1/2"	8
6	REMP0034	DIGITAL BUTTON IP68 ALUM. AIR	1
7	REMP0033	DIGITAL BUTTON IP68 ALUM. WATER	3
8	RROT0063	INTERNAL GREY DRAINPIPE	5
8.1	RPOR0001	WHITE DRAIN SET 1/2"	1
9	REMP0032	DIN CURVED GRATING WIDTH 195 mm	636
10	RPOR0024	LIGHT SPAS SI800	2
11	RPOR0236	JET BODY SET RD 3"	17
12	REMP0058	FRONTAL JET DIRECCIONAL 3"	8
13	REMP0059	FRONTAL JET ROT 1 CHORRO 3"	8
14	REMP0060	FRONTAL JET ROT 2 CHORRO 3"	1
15	RPOR0235	JET BODY SET RD 2"	36
16	REMP0056	JET DIRECTIONAL 2" WHITE	22
17	REMP0057	JET 2" TWIN ROTO WHITE	14
33	RPOR0094	BIG HEADREST - PACIFIC-ANTARTIC-EVOLUTION	2
43	REMP0052	VACUUM POINT	1
42	REMP0010	PRESSURE NOZZLE	4

STAINLESS STEEL JETS + COLOUR LIGHT			
Position Num.	Part Nº SPARE	Description SPARE	Quant.
1	303325R	SPA SUPPORT	33
2	RPOR0223	WHITE SPA DRAIN 2" ADAPTOR SOCKET D.50	7
4	REMP0046	WHITE-STAINLESS STEEL AIR NOZZLE	10
5	REMP0051	WHITE SPA DRAIN 2 1/2"	8
6	REMP0034	DIGITAL BUTTON IP68 ALUM. AIR	1
7	REMP0033	DIGITAL BUTTON IP68 ALUM. WATER	3
8	RROT0063	INTERNAL GREY DRAINPIPE	5
8.1	RPOR0001	WHITE DRAIN SET 1/2"	1
9	REMP0032	DIN CURVED GRATING WIDTH 195 mm	636
10	RCOM0063	HIGH INTENSITY COLOURS LED SPOTLIGHTS + STEEL ESCUTCHEON SPOTLIGHT	2
11	RPOR0236	JET BODY SET RD 3"	17
12	RPOR0231	FRONTAL JET 3" STAINLESS STEEL DIRECTIONAL	8
13	RPOR0232	FRONTAL JET 3" STAINLESS STEEL 1 JET ROTO	8
14	RPOR0233	FRONTAL JET 3" STAINLESS STEEL TWIN ROTO	1
15	RPOR0235	JET BODY SET RD 2"	36
16	RPOR0230	FRONTAL JET 2" STAINLESS STEEL DIRECTIONAL	22
17	RPOR0260	JET TWIN ROTO 2" INOX	14
33	RPOR0094	BIG HEADREST - PACIFIC-ANTARTIC-EVOLUTION	2
43	REMP0052	VACUUM POINT	1
42	REMP0010	PRESSURE NOZZLE	4

WHITE JETS + COLOUR LIGHT			
Position Num.	Part Nº SPARE	Description SPARE	Quant.
1	303325R	SPA SUPPORT	33
2	RPOR0223	WHITE SPA DRAIN 2" ADAPTOR SOCKET D.50	7
4	REMP0029	KIT STORM AIR NOZZLE	10
5	REMP0051	WHITE SPA DRAIN 2 1/2"	8
6	REMP0034	DIGITAL BUTTON IP68 ALUM. AIR	1
7	REMP0033	DIGITAL BUTTON IP68 ALUM. WATER	3
8	RROT0063	INTERNAL GREY DRAINPIPE	5
8.1	RPOR0001	WHITE DRAIN SET 1/2"	1
9	REMP0032	DIN CURVED GRATING WIDTH 195 mm	636
10	RCOM0061	HIGH INTENSITY COLOURS LED SPOTLIGHTS + WITHE ESCUTCHEON SPOTLIGHT	2
11	RPOR0236	JET BODY SET RD 3"	17
12	REMP0058	FRONTAL JET DIRECCIONAL 3"	8
13	REMP0059	FRONTAL JET ROT 1 CHORRO 3"	8
14	REMP0060	FRONTAL JET ROT 2 CHORRO 3"	1
15	RPOR0235	JET BODY SET RD 2"	36
16	REMP0056	JET DIRECTIONAL 2" WHITE	22
17	REMP0057	JET 2" TWIN ROTO WHITE	14
33	RPOR0094	BIG HEADREST - PACIFIC-ANTARTIC-EVOLUTION	2
43	REMP0052	VACUUM POINT	1
42	REMP0010	PRESSURE NOZZLE	4

According to our policy of continuous improvement, dimensions, features or components of this product can be partially or completely changed without prior notice. It's Customer responsibility to verify that this is the last version of the drawing

Change No.	Date	Name	Modification
05	08/08/2014	I.Pozo	Change number grating
04	12/06/2014	I.Pozo	New spare template
03	26/05/2014	I.Pozo	New templates
02	04/05/2011	F.Gómez	New electrical box, buttons and water level system
00	22/01/2009	M.Baraut	Drawing creation

Remarks Dimensions in mm. General Tolerances +/- 10mm			<b>SPARE DRAWING</b>		
Drawn	22/01/2009	M.Baraut		Part Number	43638
Checked	22/01/2009	I.Nicolas		Rev.	05
Scale 1:30	General Tolerance DIN 7168 ISO 2768g			First Angle Projection	
Sheet 3/3	Property of IBERSPA S.L. Avda. Pla d'Urgell 2-8 25200 Cervera, Spain. Don't use without permission. Keep this information confidential and use it solely for the permitted purpose.				