

Disclaimer

ELITE

english



Our commitment: excellence



CONTENTS

1. Product specifications and technical characteristics
 - 1.1. Table of characteristics
 - 1.2. Packaging
 - 1.3. Measurements
2. Checklist of quality controls passed
3. Certificate of CE conformity
4. Certificate of warranty
5. Characteristics and design standards
6. Exploded view
7. Recommendations
 - 7.1. Packaging
 - 7.2. Storage
 - 7.3. Transport
 - 7.4. Location
 - 7.5. Operation fundamentals
 - 7.6. Installation
 - 7.6.1. Electrolysis cell installation
 - 7.6.2. Electrical connection of the electrolysis cell
 - 7.6.3. Installation of the external flow detector
 - 7.6.4. Installation of the pH/ORP sensor
 - 7.6.5. Start-up
 - 7.6.6. Controls and indicators
 - 7.6.7. System configuration
 - 7.7. Operation
 - 7.7.1. System on stand-by
 - 7.7.2. Production level selection
 - 7.7.3. Salinity test
 - 7.7.4. pH/ORP set point programming
 - 7.7.5. Alarms
8. Maintenance
 - 8.1. Electrolysis cell
 - 8.2. Calibration of the pH sensor
 - 8.2.1. "Fast" mode
 - 8.2.2. "Standard" mode
 - 8.3. Calibration of the ORP sensor
 - 8.4. Maintenance of the pH/ORP sensors
9. Troubleshooting
10. "DO AND DO NOT" table



1. Product specifications and technical characteristics



ASTRALPOOL CHLORE ELITE SALT ELECTROLYSIS

Self-cleaning salt electrolysis systems, with integrated pH/ORP control.

- Microprocessor control.
- Membrane keypad with control keys and operation indication leds.
- Control I/O: 2 inputs (potential-free contact type) for monitoring the state of the automatic cover and the external flow switch.
- Cell output: production control (11 discrete levels).
- Integrated pH/ORP controller.
- Self-cleaning system with automatic polarity switch of the electrodes.
- Easy view display.
- High efficiency TWIN CELL® electrodes.
- Natural convection cooling.
- Power supply: Blue ABS (RAL 5002) with aluminium base.
- Electrolysis cell and sensor holder: transparent blue methacrylate, direct gluing to PVC D63 pipe allowed.
- Double flow detection system: integrated (gas detector) and external (flow switch).
- pH/ORP sensors: gel electrolyte and plastic body (Noryl PPO).
- Electrode state auto-diagnostic. Replacement warning.

MODEL	DESCRIPTION
42353	Salt electrolysis ELITE 10-12 g/h 60 - 80 m ³
42354	Salt electrolysis ELITE 20-24 g/h 100 - 140 m ³
42355	Salt electrolysis ELITE 25-32 g/h 140 - 170 m ³

1.1. Table of characteristics

	ELITE 60	ELITE 100	ELITE 160
Code	42353	42354	42355
Standard working voltage	230 V AC, 50 Hz.		
Output (dc)	12 A	24 A	32 A
Production (g/h)	10 - 12	20 -24	25 - 32
Flow detector	Gas detector + flow switch		
Salinity range / Temperature	4 – 6 g./l. / +15 – 40°C		
Electrodes	SELF-CLEANING coated Titanium Estimated lifetime: 4.000 – 7.000 hours of operation (depending on water quality)		
Production control	0 – 100 % (11 production levels)		
Cover control	Input for potential free contact Programmable reduction of production from control panel when closed cover [10 ... 90%]		
Polarity switch	Programmable from control panel: 2/3 hours + test mode		
External control	One input for potential free contact for external flow switch. Programmable contact logics from unit control panel		
Salt level protection	Automatic production protection		
Measurement range	0.0 – 9.9 (pH) / 0 – 999 mV (ORP)		
Control range	7.0 – 7.8 (pH) / 650 – 800 mV (ORP)		
Precision	± 0.1 pH / ± 1 mV (ORP)		
Calibration	Automatic with calibration solutions		
Control outputs [pH]	One output 230 V / 500 mA for dosage pump connection		
pH/ORP sensors	PPO body, range 0 – 12 (pH) / ± 2000 mV (ORP), solid electrolyte		
Flow detector	PPO Noryl GFN3 Casing / paddle, stainless steel 1,4571 shaft, EPDM O-ring		

1.2. Packaging

MODEL	STANDARD UNITS	MEASUREMENTS (mm)	VOLUME	MANUFACTURER
42353	1	445 x 435 x 240	0,05	ID ELECTROQUIMICA
42354	1	445 x 435 x 240	0,05	ID ELECTROQUIMICA
42355	1	445 x 435 x 240	0,05	ID ELECTROQUIMICA

1.3. Measurements

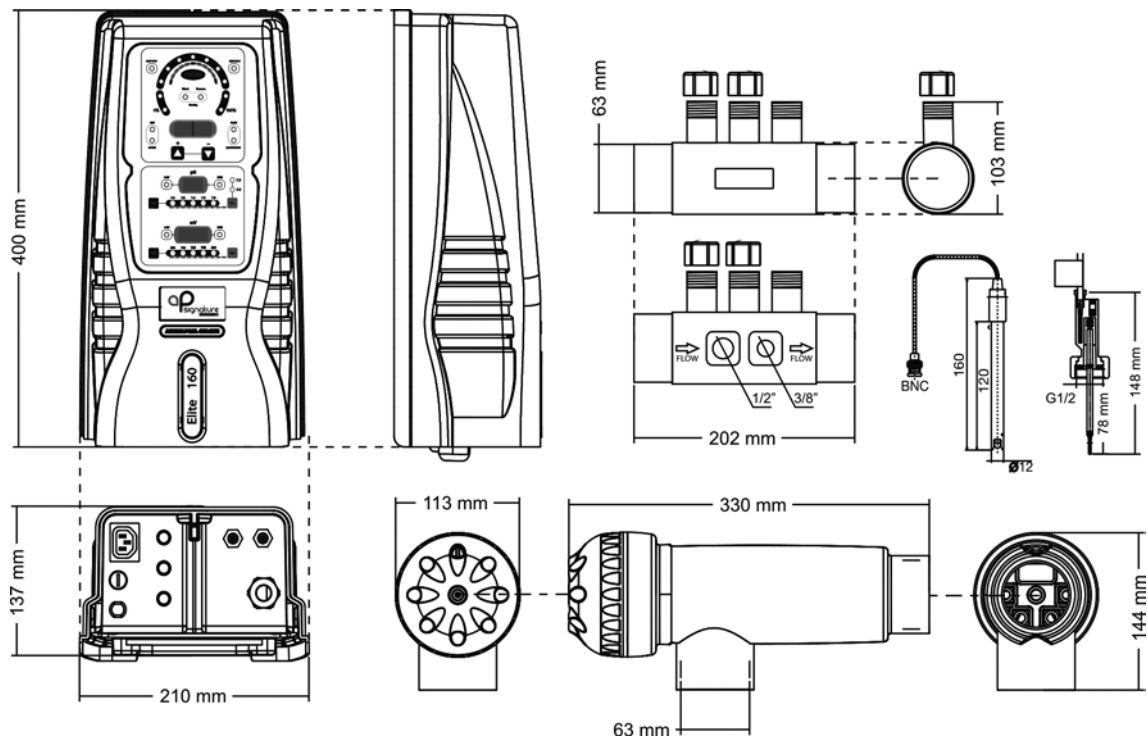

2. Checklist of quality controls passed

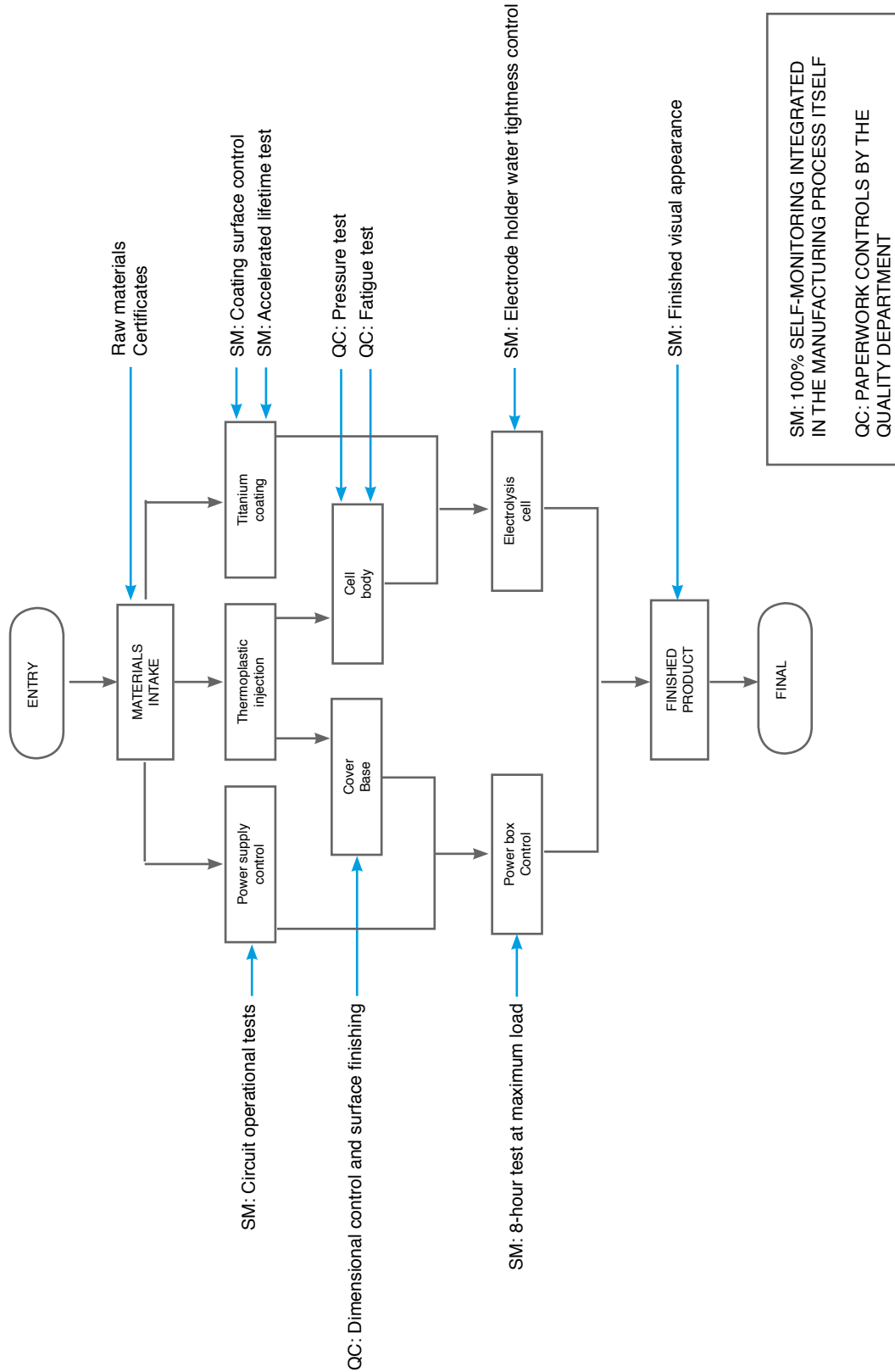

3. Certificate of CE conformity

I.D. ELECTROQUÍMICA, S.L., CERTIFIES THAT:

The products listed above are in compliance with:

Certified products:

- SALT ELECTROLYSIS SYSTEM
 - Models:
 - 42353 ASTRALPOOL CHLORE ELITE 60
 - 42354 ASTRALPOOL CHLORE ELITE 100
 - 42355 ASTRALPOOL CHLORE ELITE 160

Directives and Regulations applied:

- Directive 73/23/EEC: Low Voltage Directive.
- Directive 89/336/EEC: Electromagnetic Compatibility Directive.
- European Standard EN 61558-1:1999, and all its modifications.

Alicante, April 1st, 2008

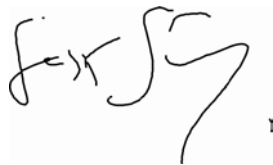

Gaspar Sánchez Cano

General Manager

4. Certificate of warranty

GENERAL ASPECTS

1.1. According to these provisions, the seller guarantees that the guaranteed product is in perfect condition upon delivery.

1.2. The Total Warranty period is 5 YEARS for the following parts:

Code 4408041301	COVER ELITE
Code 4408041302	KEYPAD ELITE
Code 4408041101	CONTROLLER WALL BASE
Code 4408041116	CONTROLLER SCREW BASE
Code 4408041117	CONTACT PROTECTION COVER
Code 4408041122	CELL BODY

For the rest of the product the Total Warranty period is 2 YEARS.

1.3. The Warranty period will be calculated as of delivery to the purchaser. The electrode is covered by a 2-YEAR WARRANTY (or 5.000 hours), which is not extendable. The pH/ORP sensors are covered by a 6-MONTH, non-renewable warranty.

1.4. Should the Product be faulty and the seller is notified during the Guarantee Period, he shall repair or replace the Product at his own cost wherever he sees fit, unless this is either impossible or out of proportion.

1.5. When the Product cannot be repaired or replaced, the buyer may request a proportional price reduction or, if the fault is important enough, rescission of the sales contract.

1.6. Parts replaced or repaired pursuant to this warranty shall not extend the warranty period of the original Product, although they shall have their own warranty.

1.7. For this warranty to be effective, the buyer shall accredit the date of acquisition and delivery of the Product.

1.8. When the buyer alleges a fault in the product over six months after its delivery, he shall accredit the original and existence of the alleged fault.

1.9. This Warranty Certificate does not limit or prejudge consumer rights pursuant to national legislation.

SPECIAL CONDITIONS

2.1. For this warranty to be effective, the buyer must closely follow the manufacturer's instructions included in the documentation supplied with the product, as applicable to each product range and model.

2.2. Whenever a schedule is defined for the replacement, maintenance or cleaning of certain product parts or components, the warranty shall only be valid when said schedule has been correctly followed.

LIMITATIONS

3.1. This warranty shall only be applicable to sales to consumers, with consumer being defined as a person who purchases the product for other than professional purposes.

3.2. No warranty is applicable to normal wear or the product, parts, components and/or fungible or consumable materials (except the electrode).

3.3. The warranty does not cover cases in which the product: (i) has been incorrectly treated; (ii) has been inspected, repaired, maintained or handled by an unauthorised person; (iii) has been repaired or maintained with non-original parts, or (iv) has been incorrectly installed or started up.

3.4. When a faulty product results from incorrect installation or start-up, this warranty shall only be applicable when the installation or start-up forms part of the product contract of sale and had been performed by the seller or under the seller's responsibility.

3.5. Damage or faults due to any of the following causes:

- Operation at salinity values of less than 3 g of sodium chloride per litre and/or temperatures lower than 15°C (59°F) or higher than 40°C (104°F).
- Operation at a pH of more than 7.6.
- Use of explicitly unauthorised chemicals.
- Exposure to corrosive environments and/or temperatures of less than 0°C (32°F) or more than 50°C (125°F).

5. Characteristics and design standards

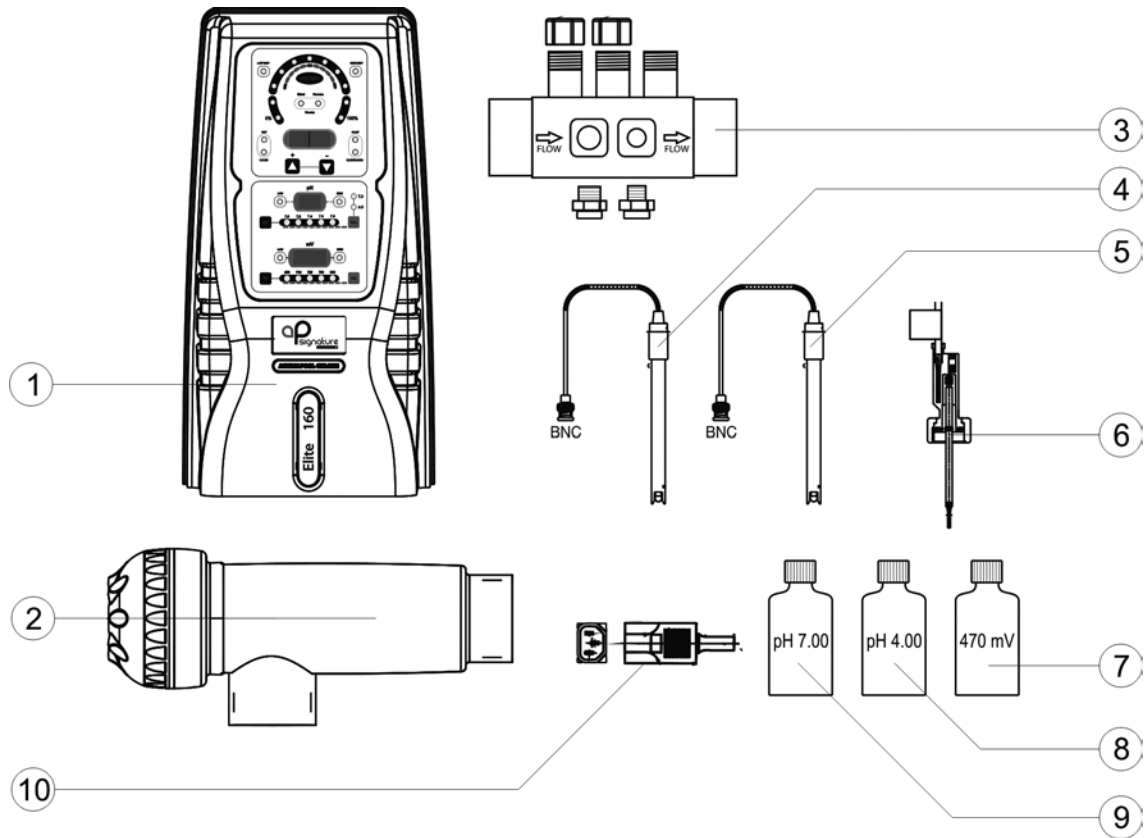

1. Power supply
2. Electrolysis cell
3. Sensor holder
4. pH sensor
5. ORP sensor
6. External flow detector (flow switch)
7. ORP 470 mV Calibration solution
8. pH 4.00 Calibration solution
9. pH 7.00 Calibration solution
10. CEE22 connector for dosage pump

The power supply was designed in accordance with the EN 61558 European Standard. The electrolysis cell and the sensor holder were designed for use in pools with a maximum temperature of 40°C, with pH, hardness and alkalinity levels within the limits stated in the corresponding regulations. Water should be maintained within the parameters shown below:

pH	7.2 – 7.6
Alkalinity	80 – 150 ppm
Isocyanuric	0 – 30 ppm

SENSOR HOLDER

The AstralPool Chlore Elite systems are supplied with a sensor holder that allows easy installation of the control and safety elements included with the unit (pH/ORP sensors and external flow detector), as well as other items such as an injection valve for pH control or an additional ground connection. This sensor holder allows direct gluing to 63 mm PVC pipes.

EXTERNAL FLOW DETECTOR

The AstralPool Chlore Elite systems have a double flow detector that avoids the operation of the system in the absence of a suitable water flow through the electrolysis cell, ensuring this way its optimal operation at any moment.

INTEGRATED pH/ORP CONTROLLER

The AstralPool Chlore Elite systems include an integrated pH/ORP controller, adding to the advantages of the salt electrolysis treatment of the swimming pool water, the self-control of the recommended values of pH and ORP, and providing an integral and automatic treatment of your swimming pool water.

6. Exploded view

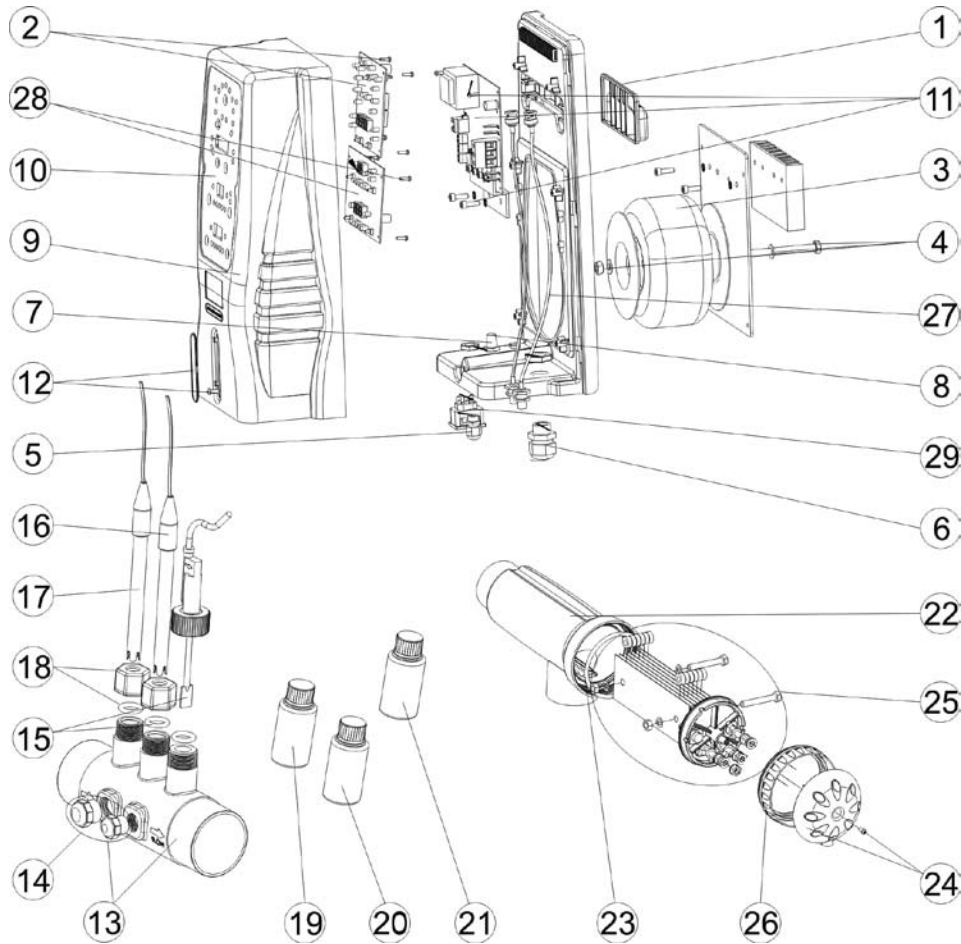

ID	CODE	DESCRIPTION	ID	CODE	DESCRIPTION
1	4408041101	CONTROLLER WALL BASE	14	4408041307	ELECTRODE HOLDER PLUGS PVC 3/8" & 1/2"
2	4408041201	ELECTROLYSIS DISPLAYING CARD	15	4408041211	FLOW SWITCH
3	4408041106	POWER TRANSFORMER 190 VA 42353	16	4408041309	PH SENSOR
3	4408041107	POWER TRANSFORMER 370 VA 42354	17	4408041308	ORP SENSOR
3	4408041202	POWER TRANSFORMER 480 VA 42355	18	4408041310	CONNECTOR 12 mm-1/2"
4	4408041104	TRANSFORMER FIXATION SCREW	19	4408040605	PH 7.0 CALIBRATION SOLUTION (GREEN)
5	4408041203	CABLE GLAND M-12	20	4408040606	PH 4.0 CALIBRATION SOLUTION (RED)
6	4408041110	CABLE GLAND M-20	21	4408041017	ORP 470 MV CALIBRATION SOLUTION
7	4408041111	FUSE HOLDER	22	4408041122	CELL BODY
8	4408041113	FUSE 2 A	23	4408041118	CELL O-RING
8	4408041114	FUSE 3 A	24	4408041116	CONTACT PROTECTION COVER
8	4408041204	FUSE 4 A	25	4408041212	ELECTRODE SPARE 42353
9	4408041301	ELITE COVER	25	4408041213	ELECTRODE SPARE 42354
10	4408041302	ELITE KEYPAD	25	4408041214	ELECTRODE SPARE 42355
11	4408041303	POWER CARD AC-12 42353	26	4408041123	CELL THREADED RING
11	4408041304	POWER CARD AC-22 42354	27	4408041311	INTERNAL BNC CABLE
11	4408041305	POWER CARD AC-30 42355	28	4408041312	PH/ORP DISPLAYING CARD
12	4408041116	CONTROLLER SCREW COVER	29	4408041313	CONNECTOR CEE22 H EXTERNAL PH PUMP
13	4408041306	SENSOR HOLDER			

7. Recommendations

7.1. PACKAGING

The AstralPool Chlore Elite system is supplied correctly packed in a sealed cardboard box where the position and stacking information in order to be palletized is indicated. Any failure to comply with these indications can result in damage of the product. The components that should be found in the packaging are indicated in the operation manual.

7.2. STORAGE

The AstralPool Chlore Elite system must be stored indoors. UV rays or direct water contact can damage the package.

Maximum temperature of storage: 50°C

Minimum temperature of storage: -5°C

7.3. TRANSPORT

System boxes must be transported on adequately secured pallets. Once at the installation, transport the system to its final location in the packaging. If this is not possible, the system should be handled with maximum care.

Any frictions, bumps or contact with rough surfaces can cause damages to the external finish appearance.

7.4. LOCATION

Always install the power supply of the AstralPool Chlore Elite system vertically on a solid and rigid surface (wall). In order to guarantee a good state of conservation, the power supply should be installed in a well-ventilated dry place. Due to IP degree of the power supply of the AstralPool Chlore Elite salt electrolysis system should not be installed outdoors. The power supply should be installed a bit distant from the electrolysis cell so that it cannot accidentally suffer water splashes.

Beware of corrosive atmosphere formation due to pH decreasing solutions (specially, those ones based on hydrochloric acid "HCl"). Do not install the Astralpool Chlore System near to any stores of these chemicals. We strongly recommend the use of chemicals based on sodium bisulphate or diluted sulphuric acid.

7.5. OPERATION FUNDAMENTALS

When Astralpool Chlore Salt Electrolysis System is installed, a quantity of salt is dissolved into the swimming pool water. This salty water then passes through the electrolysis cell that is located in the plant room. When a weak electrical current is passed through the plates inside the electrolysis cell, chlorine is produced. Maintaining a level of chlorine in swimming pool water keeps the water sanitised and healthy to swim in.

The Astralpool Chlore Salt Electrolysis System will produce chlorine whenever the pool circulation system (pump and filter) is operational. The Astralpool Chlore systems will also monitor the pH level and activate a dosing pump to add pH reducing chemical if necessary. Moreover, the integrated ORP controller will automatically control the water chlorine level by connecting/disconnecting the electrolysis system when necessary.

Nevertheless, it is important to continue testing the pool water chlorine, pH and alkalinity levels, and to adjust these values as required. The chlorine level can be increased via the integrated ORP controller. The pH level will be reduced by the AstralPool Chlore Elite system, and the water chemical balance must be maintained manually.

The Astralpool Chlore Salt Electrolysis System consists of two elements: an electrolysis cell and a power supply. The electrolysis cell contains a quantity of titanium plates (electrodes). The power supply is provided with several safety devices, which are activated in case of system irregular operation of the system, as well as a microprocessor driven control system.

The AstralPool Chlore Elite Systems have an automatic cleaning system that avoids scale formation on the electrodes.

7.6. INSTALLATION

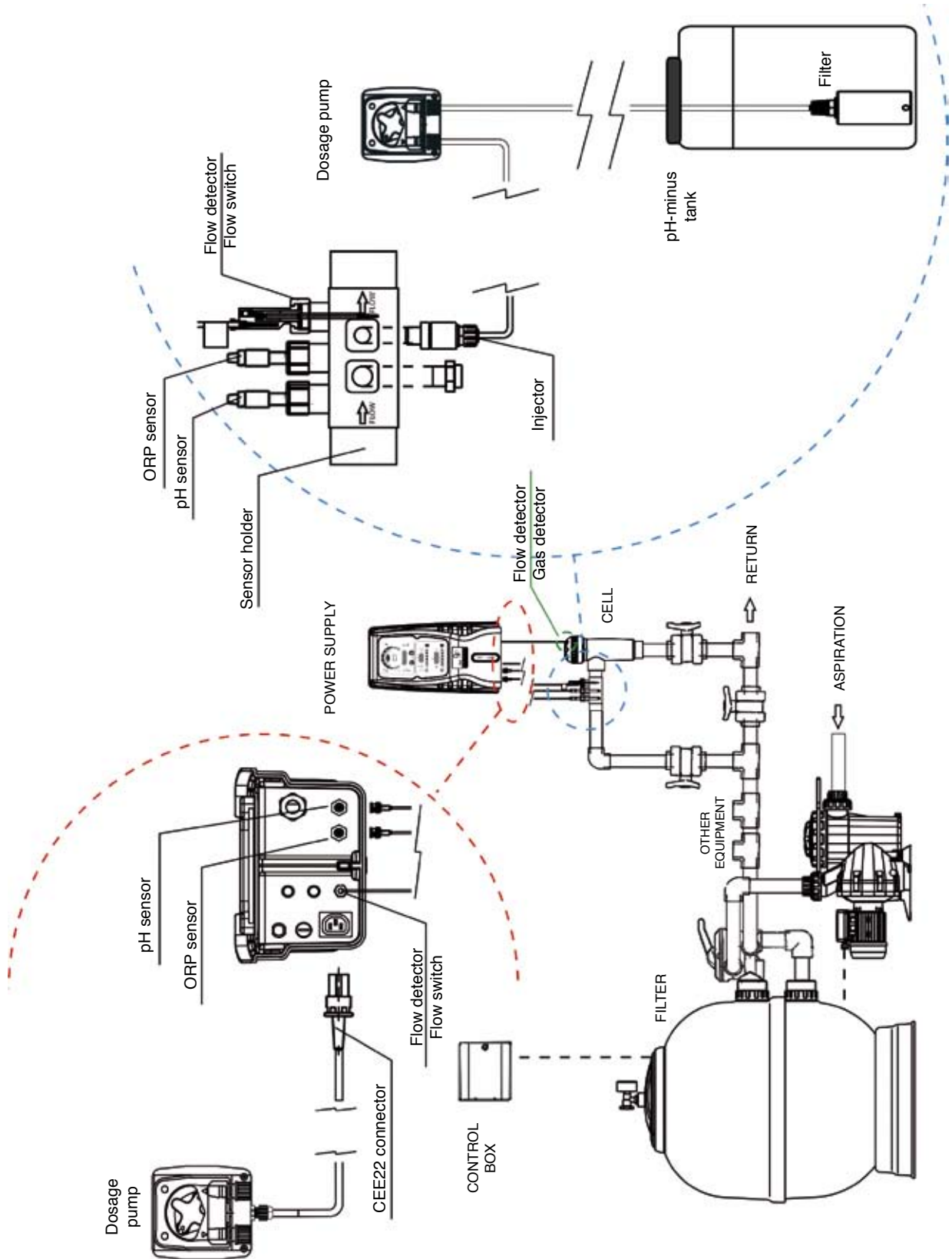

7.6.1. ELECTROLYSIS CELL INSTALLATION

The electrolysis cell is made of a transparent polymer in whose interior the electrodes are placed. The electrolysis cell must be always installed indoors and **after the pool filter**, and after any other equipment (heat pumps, control systems, etc.). The installation of the cell should allow easy access to the installed electrodes by the user. It is highly recommended to install the electrolysis cell **VERTICALLY**, in a place of the pipe that can be easily isolated from the rest of the installation by two valves, so that the tasks of maintenance can be carried out with no need of partial or total draining of the swimming pool.

Where the cell is installed on a by-pass (recommended option), a valve to regulate the flow must be introduced. Previously to installation, please consider the following commentaries:

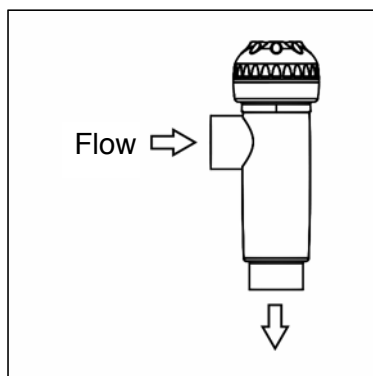

- ① Flow direction marked in the cell must be respected. Recirculation system must guarantee the minimum flow stated in the Table of Technical Specifications (see section 8 from the Operation Manual).

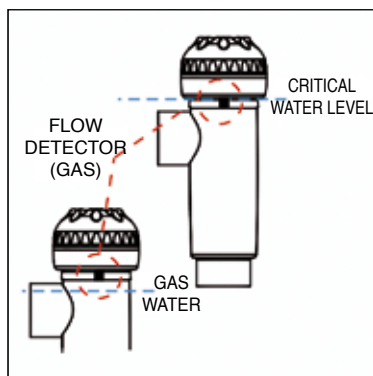

- ② The system flow detector activates if there is not recirculation (flow) of water through the cell or if flow is very low. If electrolysis gases are not properly removed through the electrolysis cell, the generated gas bubble electrically isolates the auxiliary electrode (electronic detection). Therefore, when locating the electrodes in the cell, the level sensor (auxiliary electrode) will have to be located in the higher area of the cell. The safest orientation is shown in the recommended installation diagram.

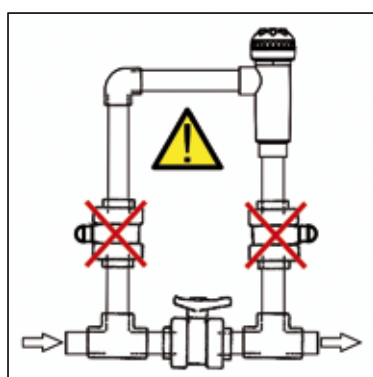

- ③ **WARNING:** if the in-out valves of the electrolysis cell are closed simultaneously, the flow detector (gas detector) will not work correctly, with the consequent risk of cell breakdown. Although this situation is extremely unusual, since the Astralpool Chlore Elite System has an additional external flow detector (flow switch), it can be easily avoided once the equipment has been installed, by locking at opened position the return valve to the swimming pool, so it cannot accidentally be manipulated.

Other configurations would only be acceptable in the case that they allow for detection of gas bubbles when water flow through the cell is too low.

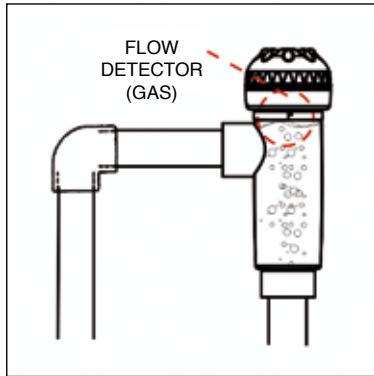

Recommended installation

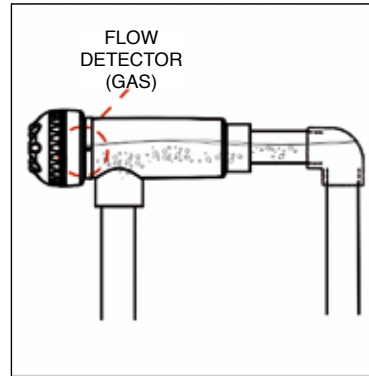

Allowed installation (not recommended)

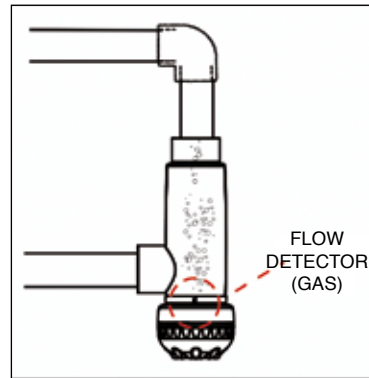
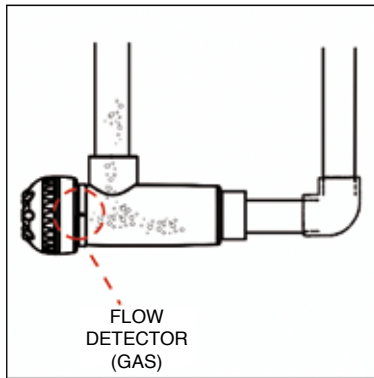

Not allowed installations

The electrodes must be inserted in the electrolysis cell, fitting the central electrode through the guides located at the top and bottom of the cell.

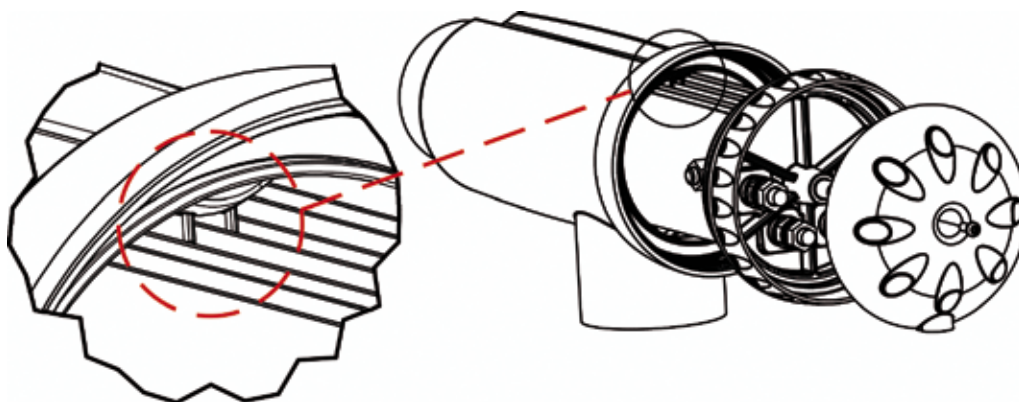

7.6.2. ELECTRICAL CONNECTION OF THE ELECTROLYSIS CELL

Make the interconnection between the electrolysis cell and the power supply according to the following scheme. Due to relatively high current intensity circulating do not modify or cut either the length or section of the supplied cables without making a previous consultation to an authorized Astralpool distributor. The cable connecting the electrolysis cell and the power supply must necessarily be of the maximum length recommended in the Manual: Elite 60 / 42353, 7.5 m.; Elite 100 / 42354, 4.0 m.; Elite 160 / 42355, 3.0 m.

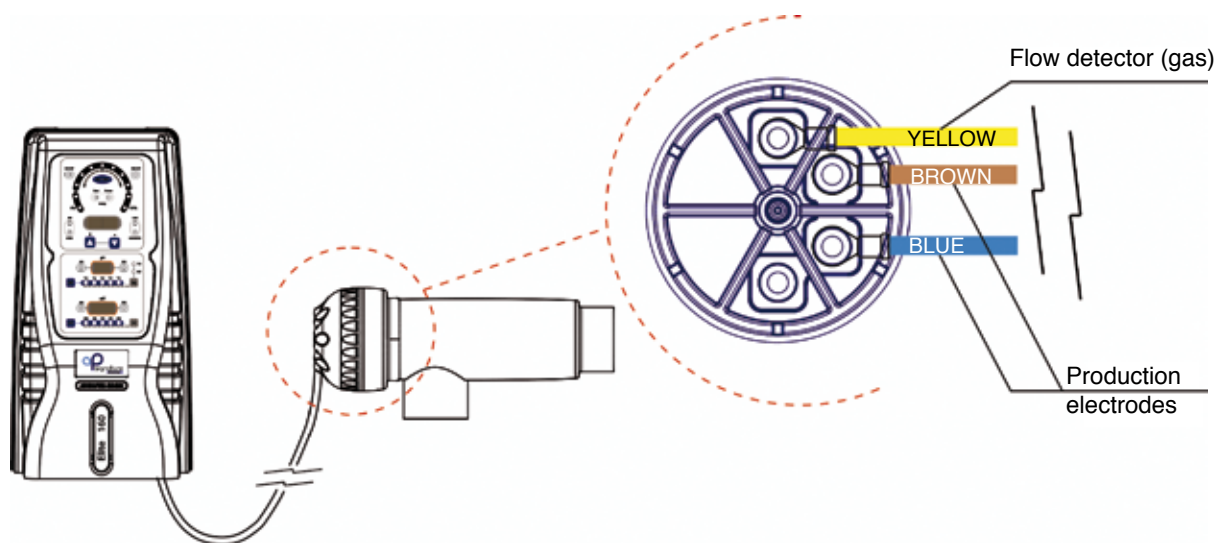

7.6.3. INSTALLATION OF THE EXTERNAL FLOW DETECTOR

Besides the internal flow detector (gas detector) installed in all Astralpool Chlore equipment, the Elite range systems have an additional mechanical flow detector (flow switch).

- Glue the sensor holder to a section of the pipe at the entrance to the electrolysis cell. It should always be installed in a horizontal position relative to the ground.
- Install the flow detector (flow switch) supplied vertically in the sensor holder supplied with the equipment.

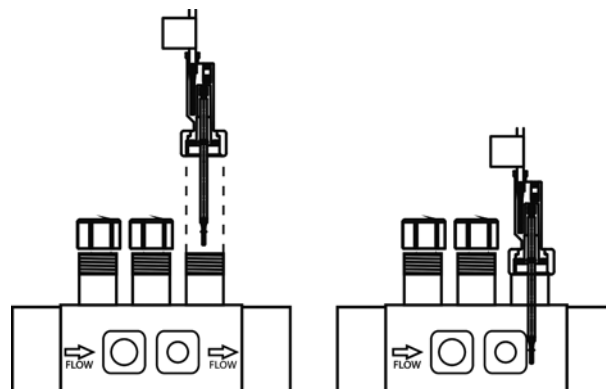

- There is an arrow on the head of the flow detector. Make sure that this arrow is parallel to the pipe shaft and pointing in the direction that the water flows.

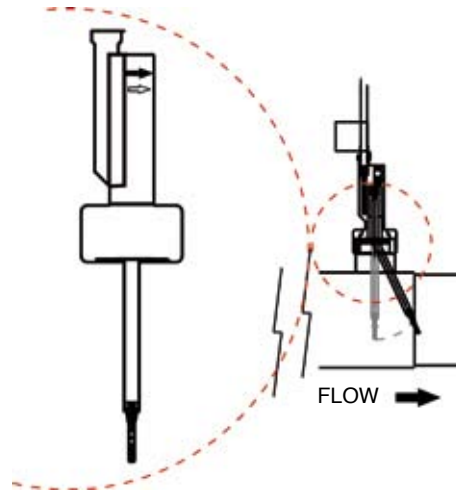

- Do not install the flow detector near magnetic objects. They could affect the operation of the magnetic device it contains and reduce its reliability.

7.6.4. INSTALLATION OF THE PH/ORP SENSOR

- Insert the pH and ORP sensors into their corresponding places of the holder.
- Loosen the connection screws and insert the sensor into the holder.

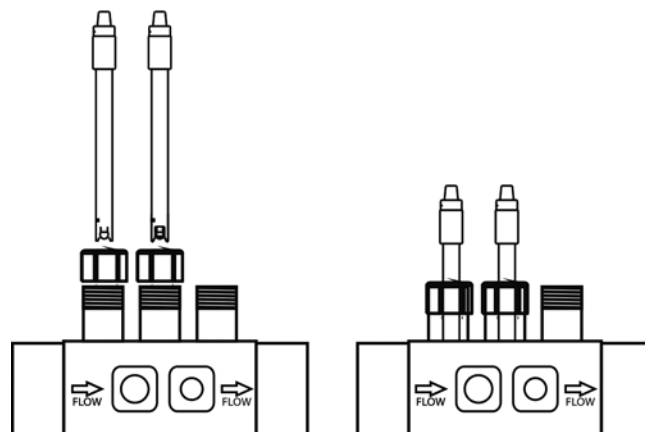

- The sensors must be installed in the holder so that it is guaranteed that the sensors located in their ends are always submerged in the water circulating through the pipe.
- **Always install the sensors vertically or with a maximum inclination of 40°.**

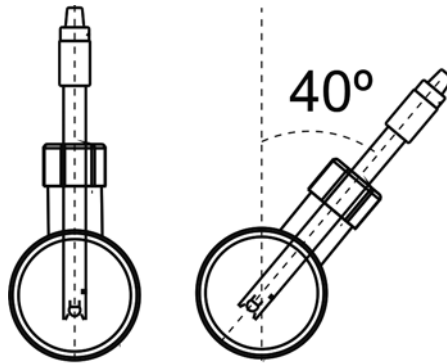

- Connect the pH y ORP sensors supplied with the unit to the BNC connectors located on the bottom part.
- The AstralPool Chlore Elite systems have a connector in its bottom part in order to connect a dosage pump for the water pH control. This dosage pump can be connected through a CEE22 connector supplied in the package.

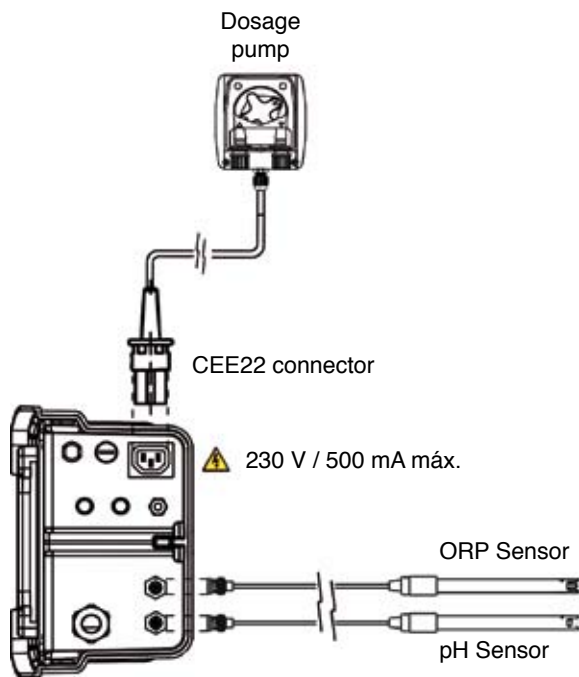

Direct connection

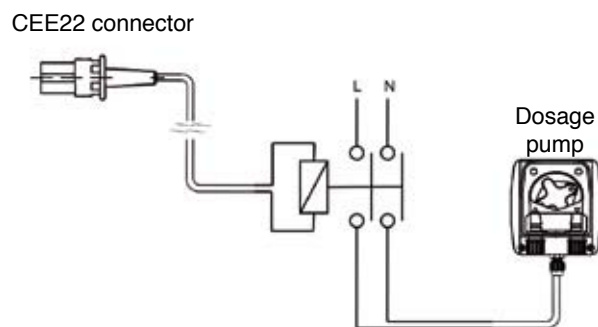

Indirect connection
(for pump with consumption over 500 mA)

7.6.5. START-UP

- Check that the filter is 100% clean, and ensure that the swimming pool and the installation do not contain copper, iron or algae. Ensure that any heating equipment on the pool is suitable for use in salt water.
- Ensure that the swimming pool water is balanced. Balanced water enables the chlorine that is produced to be used more efficiently and effectively, and ensures that the life of the electrodes is prolonged. Water should be maintained within the parameters shown below.
 - a) pH must be in the range 7.2-7.6
 - b) Total alkalinity must be in the range 80-120 ppm
- Although the AstralPool Chlore Elite system can operate within a salinity range of 4 – 6 g/l, the minimum recommended level of salt, 5 g/l, should be maintained by adding 5 kg per m³ of water if the water did not previously contain salt. Always use common salt (sodium chloride), without additives like iodides, that is “apt for human consumption”. Never add the salt through the cell. Add it directly to the swimming pool or into the balance tank.
- When adding the salt, and in case the swimming pool is going to be used immediately, carry out a treatment with chlorine. An initial dose of 2 g/m³ of trichloroisocyanuric acid may be added.
- Before starting up the salt chlorinator, disconnect the power supply to the salt chlorinator and run the pump for 24 hours to ensure that the salt is completely dissolved.
- Next, reconnect the power supply and turn on the salt chlorinator, locating the production level so that free chlorine concentration stays within the recommended range (0.5 – 1.5 ppm).
NOTE: in order to establish the free chlorine level you will need to use a test kit.
- In outdoor swimming pools it is advisable to maintain a level of 25-30 g/m³ of chlorine stabiliser (cyanuric acid) in the pool. A level of 75 ppm should be never exceeded. This will help to stop the chlorine that is in the water from being destroyed by the sun.

7.6.6. CONTROLS AND INDICATORS

AstralPool Chlore Elite electrolysis systems are equipped with a control panel on the front.

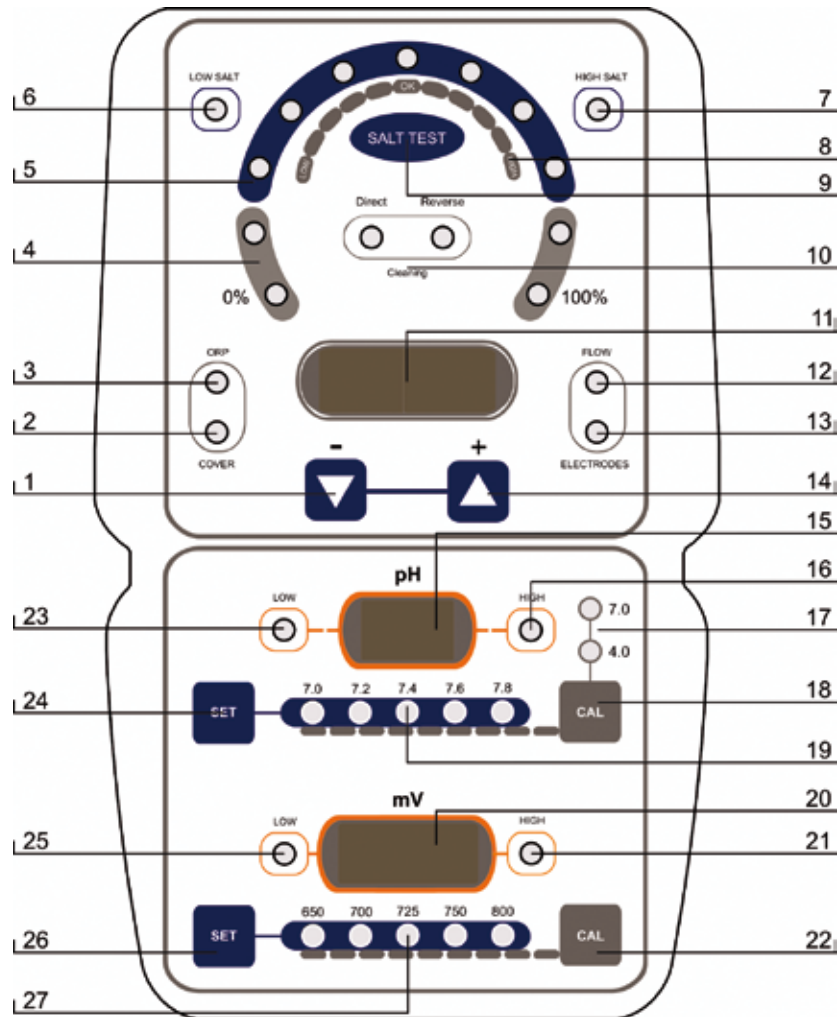

- | | |
|--|---|
| 1. Key “-” (decrease production / programming menu navigation) | 14. Key “+” (increase production / programming menu navigation) |
| 2. Indicator of activated AUTOMATIC COVER control | 15. Display of water pH |
| 3. Indicator of activated ORP CONTROL | 16. Indicator of HIGH PH ALARM (> 8.5) |
| 4. Production scale (%) | 17. Indicator of pH CALIBRATION SOLUTION [7.0 / 4.0] |
| 5. PRODUCTION+SALINITY TEST scale | 18. Key for pH CALIBRATION MODE |
| 6. Indicator of LOW SALINITY | 19. Indicator of PH SETPOINT |
| 7. Indicator of HIGH SALINITY | 20. Display of water ORP (mV) |
| 8. SALINITY scale (qualitative) | 21. Indicator HIGH ORP ALARM (> 850 mV) |
| 9. Key for “SALINITY TEST” | 22. Key for ORP (mV) CALIBRATION MODE |
| 10. SELF-CLEANING indicators (DIRECT/REVERSE) polarity | 23. Indicator of LOW PH ALARM (< 6.5) |
| 11. Display of SYSTEM INFORMATION | 24. Key for PH SETPOINT PROGRAMMING |
| 12. Indicator of FLOW ALARM | 25. Indicator LOW ORP ALARM (< 650 mV) |
| 13. Indicator of ELECTRODE passivation ALARM | 26. Key for ORP (mV) SETPOINT programming |
| | 27. Indicator of ORP (mV) SETPOINT |

Besides basic operations, the AstralPool Chlore Elite electrolysis system has two inputs for voltage-free contacts, enabling the connection of additional external controls. They are located on connector **[CN7]** of the unit's main circuit, on the base.

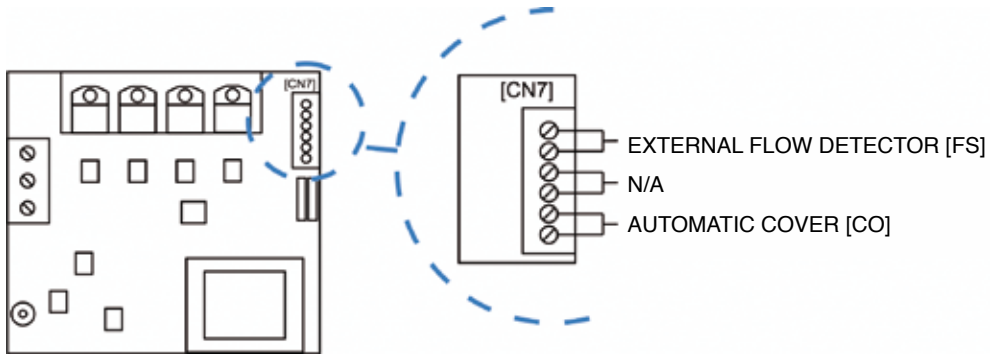

The logic associated to these two inputs can be programmed during the system configuration process. (see next section).

- **[FS] EXTERNAL FLOW DETECTOR CONTROL:** input for potential-free contact. When the contact connected to this input is open (external flow detector at rest), the electrolysis system switches off due to the flow alarm. Connect the external flow detector wiring to the respective input [FS] on the unit's main control card.

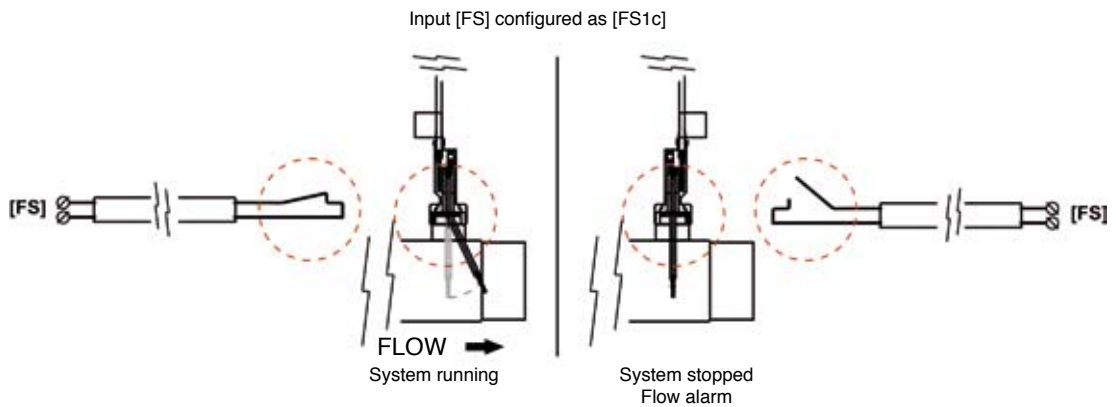



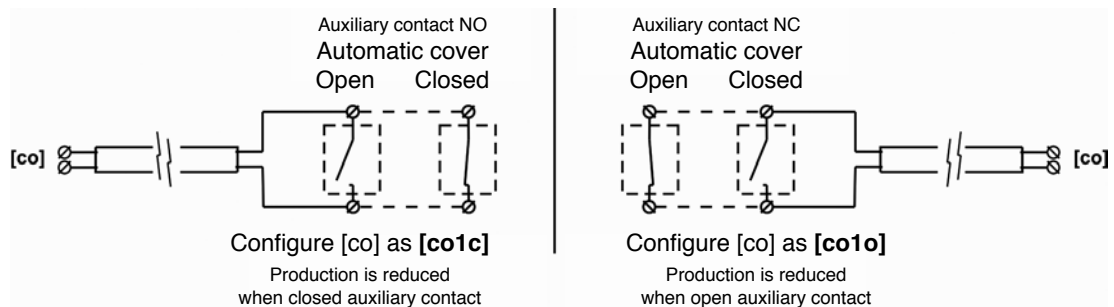















- **[co] AUTOMATIC COVER CONTROL:** input for potential-free contact. Depending on the status of the contact connected to it on the automatic cover's electric panel, this input enables you to programme a reduction of the equipment's output current to a percentage of its nominal value.



7.6.7. SYSTEM CONFIGURATION

The AstralPool Chlore Elite system can be reconfigured through a menu accessed from the control panel. The system must be switched off in order to access this menu, by pressing successively the “-” [1] key until “0%” led starts flickering. Once the system has been switched off, press the “-” [1] key for a few seconds until the system information screen [11] displays “CONF”. To enable selection of each menu option, keep the “SALT TEST” [9] key pressed for approximately 1 second. Select the desired parameter using the “-” [1] / “+” [14] keys and validate by pressing the “SALT TEST” [9] key for one second again. The configuration process enables you to establish the following operative parameters:

MODEL	 Elite 60	 Elite 100	 Elite 160
SOFTWARE VERSION	 Shows software version (two digits)		
POLARITY SWITCH	 Switch each 2 hours ⁽²⁾	 Switch each 3 hours	 Switch each 2 minutes ⁽¹⁾
OUTPUT LEVEL CONTROL WHEN CLOSED COVER	 --  ⁽²⁾ System may be configured to provide an output to cell in the range 10 ... 90% of its nominal capacity when the pool cover is closed.		
COVER CONTROL INPUT ACTIVATION	 Deactivated	 Activated input when closed contact ⁽²⁾	 Activated input when closed contact.
ORP/RESIDUAL CHLORINE CONTROL INPUT ACTIVATION	 Deactivated (MANUAL)	 Activated electrolysis system when closed contact (AUTO) ⁽²⁾	
GAS DETECTOR ACTIVACION	 Deactivated	 Activated electrolysis system when flooded detector ⁽²⁾	
EXTERNAL FLOW DETECTOR (FLOW SWITCH) ACTIVATION	 Deactivated	 Activated electrolysis system when closed contact ⁽²⁾	

(1) **WARNING:** only use this mode for check tasks, for short periods of time, as it could damage the electrodes.

(2) Factory defaults.

SYSTEM PROGRAMMING FLOW-SHEET

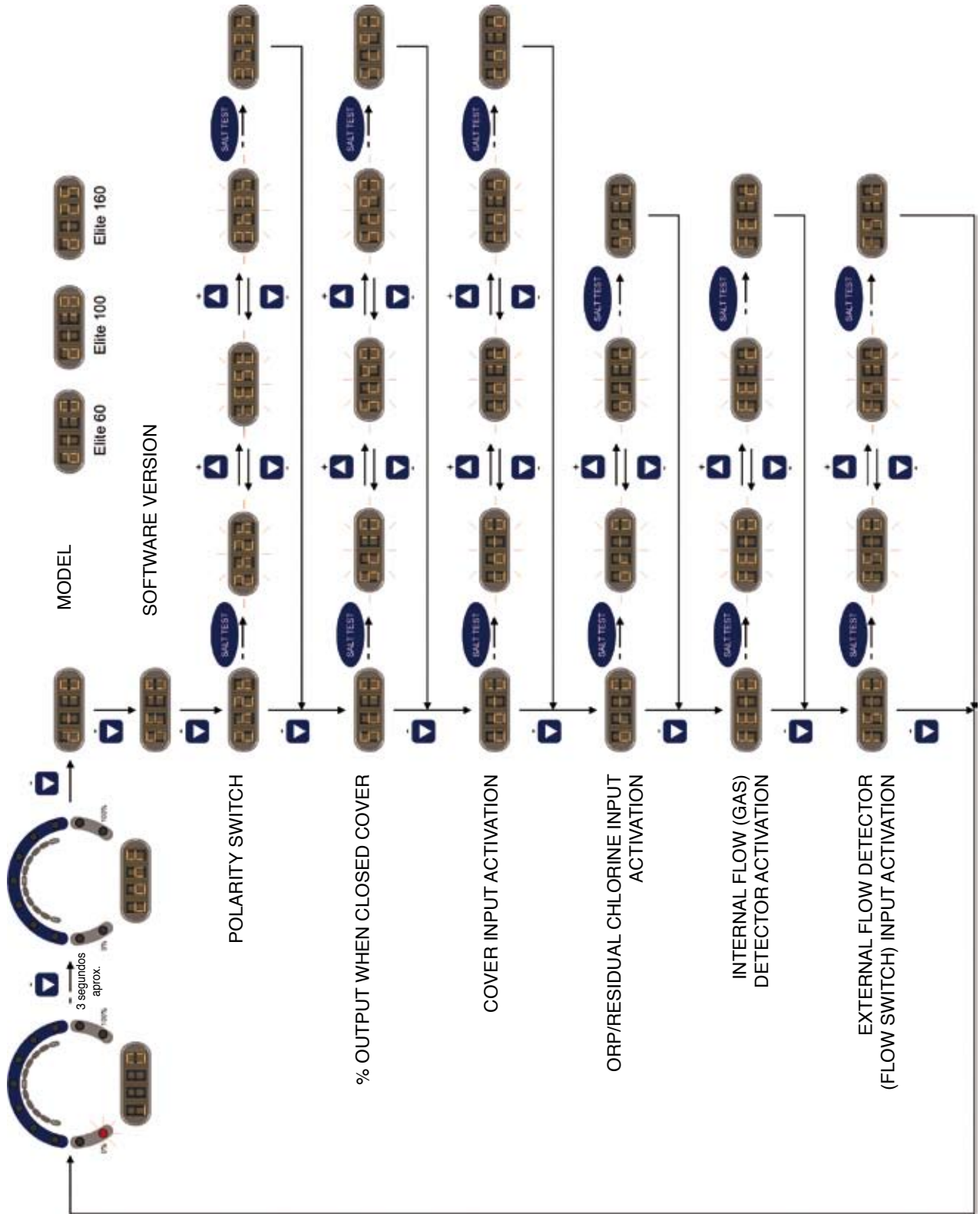

7.7. OPERATION

7.7.1. SYSTEM ON STAND-BY

The system goes into “STAND-BY” when the “-” [1] key is pressed successively until the “0%” light blinks. When this occurs, there is no production in the electrolysis cell.



7.7.2. PRODUCTION LEVEL SELECTION

To select production level, press the “-” [1] / “+” [14] keys until the desired production level light blinks. The system information screen [11] will display the value of the production scale light [4]. The system will set its production to the desired level after a few seconds.

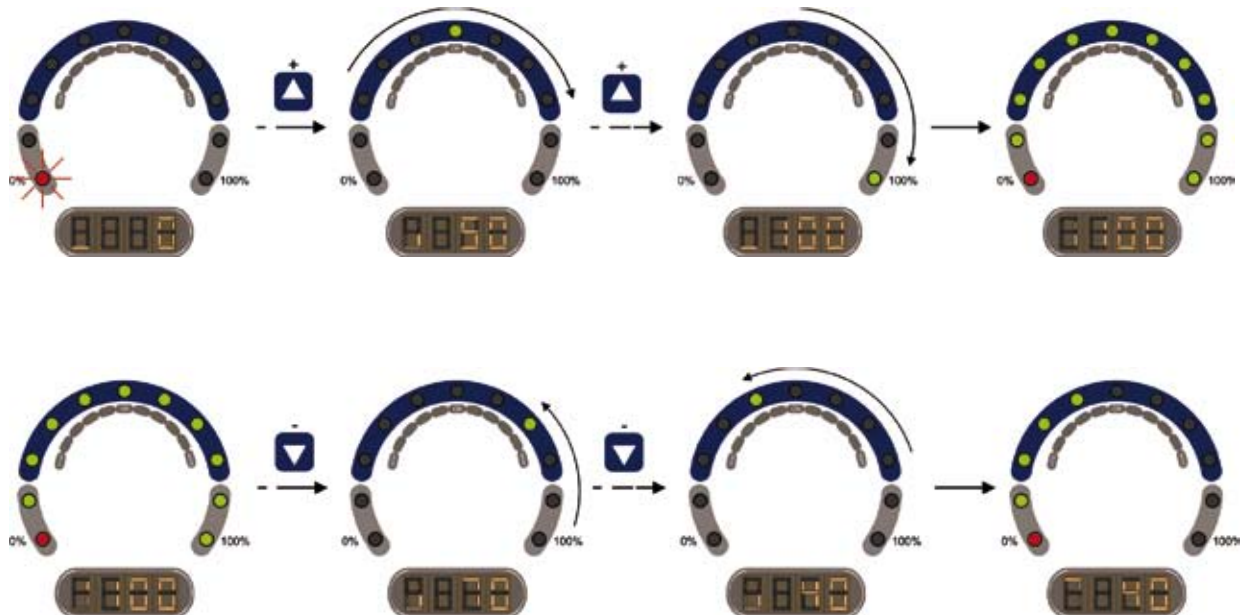

In normal conditions, the production value [4] should be the same as the programmed value, however, if the salt level in the water is outside the permitted range (“HIGH SALT” [7] or “LOW SALT” [6] alarms on), or there is a problem in the electrolysis cell (“ELECTRODES” [13] alarm on), the production value [4] could be lower than the programmed and displayed value [11].

7.7.3. SALINITY TEST

AstralPool Chlore Elite systems have an integrated system to detect the salinity level of pool water. To run the test press the “SALT TEST” [9] key. During the test, the production light will range from 20%-80% of the salinity scale [5], alternately displaying “SALT” and “TEST” on the system information screen [11]. Once the test is completed, the light will blink for a few seconds on the scale [5] on the detected salinity value. The equipment will return to normal operating mode after a few seconds.

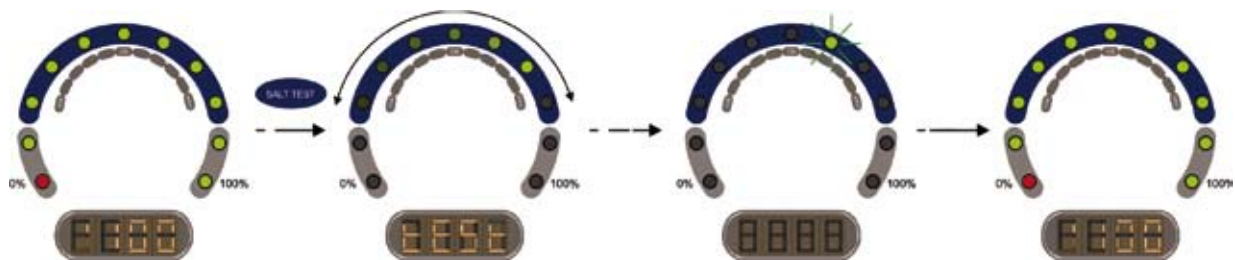

The system might show lower than actual salt levels if the temperature falls beneath 20°C.

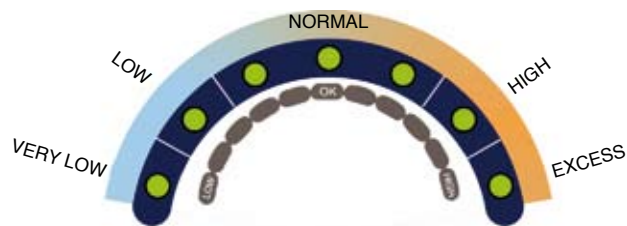

7.7.4. PH/ORP SET POINT PROGRAMMING

Keep the “**SET**” [24] key pressed until the light displays the desired pH value within the 7.0 – 7.8 range. Then release the key.



In order to program the ORP set point on the system, keep the “**SET**” [26] key pressed until the light displays the ORP desired within the 650 – 850 mV range. Then, release the key.

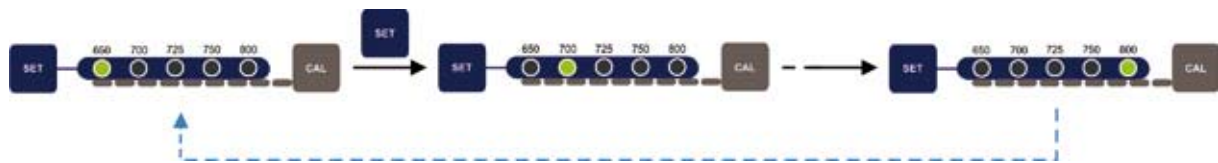

7.7.5. ALARMS

- **HIGH SALT LEVEL**

If too much salt has been added, the production level will automatically fall beneath the selected level. The “**HIGH SALT**” [7] light will stay on. In this case, empty part of the pool (10%, for instance) and add fresh water to reduce the salt concentration.

- **LOW SALT LEVEL**

If there is less than the recommended salt content in the pool, the selected output level cannot be reached. The “**LOW SALT**” [6] light will stay on. In this case, measure the salt level in the water and add the required amount of salt. The common salt (NaCl) used for electrolysis should not contain additives (anti-caking agents, iodine) and must be suitable for human consumption. The system may indicate a low salt level if the temperature falls beneath 20°C.

To precisely measure the salt level, we recommend the use of a portable salinity-temperature meter.

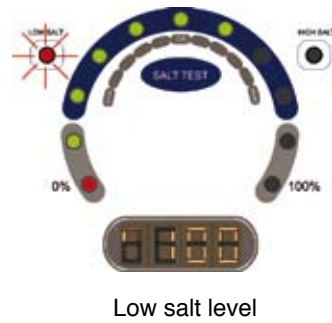

- WATER LEVEL IN CELL/FLOW DETECTOR (GAS)

If an air or gas bubble appears at the top of the electrolysis cell and the FLOW DETECTOR is not submerged, the system will automatically switch off production, with the “FLOW” [12] light blinking and “FLO” displayed on the system information screen [11]. The system automatically resets when water flows through the cell again or the bubble disappears.

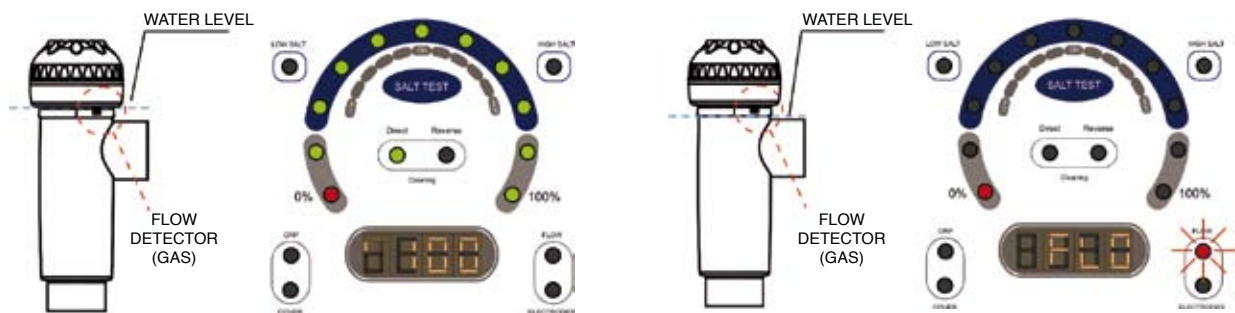

1. Submerged gas detector. System running.

2. Gas detected. System off.

- EXTERNAL FLOW DETECTOR (FLOWSWITCH)

During the system configuration process (section 7.6.7), the input for the external flow switch is activated (factory-programmed default value), the system will automatically switch off production, with the “FLOW” [12] light blinking, and “FLO” displayed on the system information screen [11]. The system automatically resets whenever water starts to flow through the flow switch again.

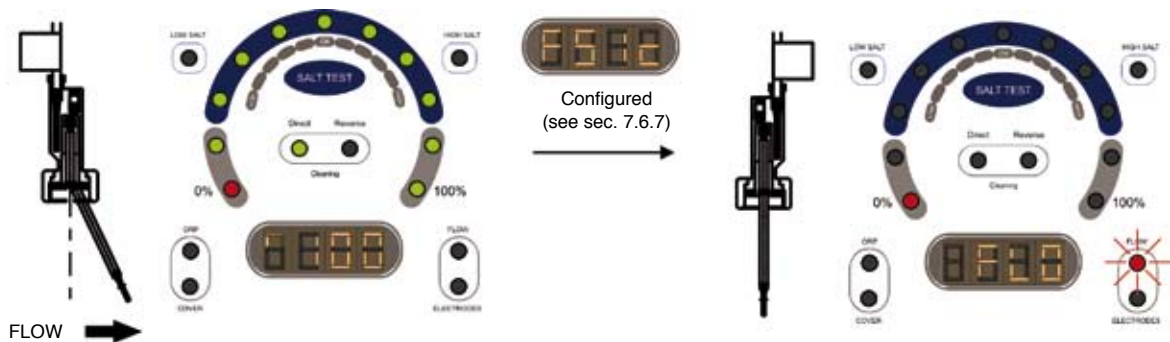

1. Activated flow detector (contact closed). System running. 2. Flow detector at rest (contact open). System off.

- ELECTRODES

The AstralPool Chlore Elite system has a light indicating malfunction of the electrolysis cell electrodes [13]. This usually occurs at the end of the electrodes' useful life, when they lose their power. However, although this is a self-cleaning system, this malfunction could also be due to excessive scaling on the electrodes when the system operates with hard water with a high pH value.

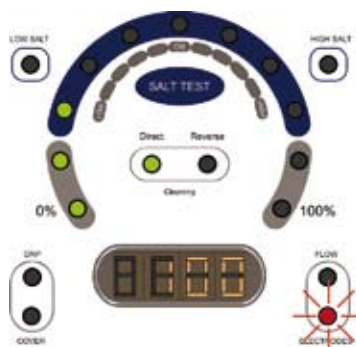

- PH / ORP OUT OF RANGE

The integrated pH/ORP control system has two ALARM lights which come on whenever a pH value of less than 6.5 "LOW" [23] or more than 8.5 "HIGH" [16] is detected, or ORP falls outside the 650 mV "LOW" [25] - 850 mV "HIGH" [21] range. When the regulator detects an active pH alarm, it opens the control output of the dosage pump (pH).

8. Maintenance

8.1. ELECTROLYSIS CELL

The electrolysis cell must be kept in suitable conditions to ensure a long lifetime. This salt chlorination unit has an automatic electrode cleaning system that helps to prevent scale build-up on the electrode surface. If the salt chlorination system is operated in accordance with these instructions, and in particular if the pool water balance is kept within the recommended parameters, it should not be necessary to manually clean the electrodes. However, if the pool water and the salt chlorination system are not maintained in line with these instructions then it may be necessary to manually clean the electrodes following the procedure outlined below:

- Stop the electrolysis system and the rest of equipment of the pool.
- Close valves and empty the electrolysis cell.
- Use diluted hydrochloric acid (a part of commercial acid in 10 parts of water), submerging the electrode package in the prepared solution for no more than 10 minutes.
- NEVER SCRAPE OR SWEEP THE CELL OR THE ELECTRODES.

The electrodes of a salt chlorination system comprise of a titanium sheet coated with a layer of noble metal oxides. The electrolysis processes that take place on their surface produce a progressive wearing down – the electrodes do have a finite life. In order to optimise electrode lifetime, please consider the following advices:

- Although all Astralpool Chlore salt electrolysis units are SELF-CLEANING, a prolonged operation of the system at pH values over 7.6 in waters of high hardness can produce scale formation on the surface of the electrodes. Scaling on the electrodes surface will progressively deteriorate the coating, causing a decrease of lifetime.
- Manually cleaning/washing the electrodes (as described above) will shorten their.
- Prolonged operation of the system at salinities lower than 3 g/l (3000 ppm) will cause a premature deterioration of the electrodes.
- Frequent use of copper based algacides will promote the formation of copper deposits on the electrodes, progressively damaging the coating.

8.2. CALIBRATION OF THE PH SENSOR

The integrated pH-controller has two calibration modes of the pH-electrode: “FAST” and “STANDARD”. We recommend carrying out it at least once a month during the period of use of the swimming pool.

8.2.1. "FAST" MODE

"FAST" MODE allows the calibration of the pH-electrode when there are small reading deviations **with no need to extract the sensor from the installation or to use calibration solutions.**

PROCEDURE:

- Be sure the point of insertion of the pH-sensor is flooded, and the pump is in recirculation.
- Using a pH-test kit, measure the water pH of the swimming pool.
- Press the "**CAL**" [18] key for approx. 5 seconds. The pH [15] screen will blink "7.0".
- Keep the "**SET**" [24] key pressed until the pH-value previously measured in the water with the pH-test kit appears. Once reached, loosen and press "**CAL**" [18] key. If no error has been detected, the system will have been calibrated.

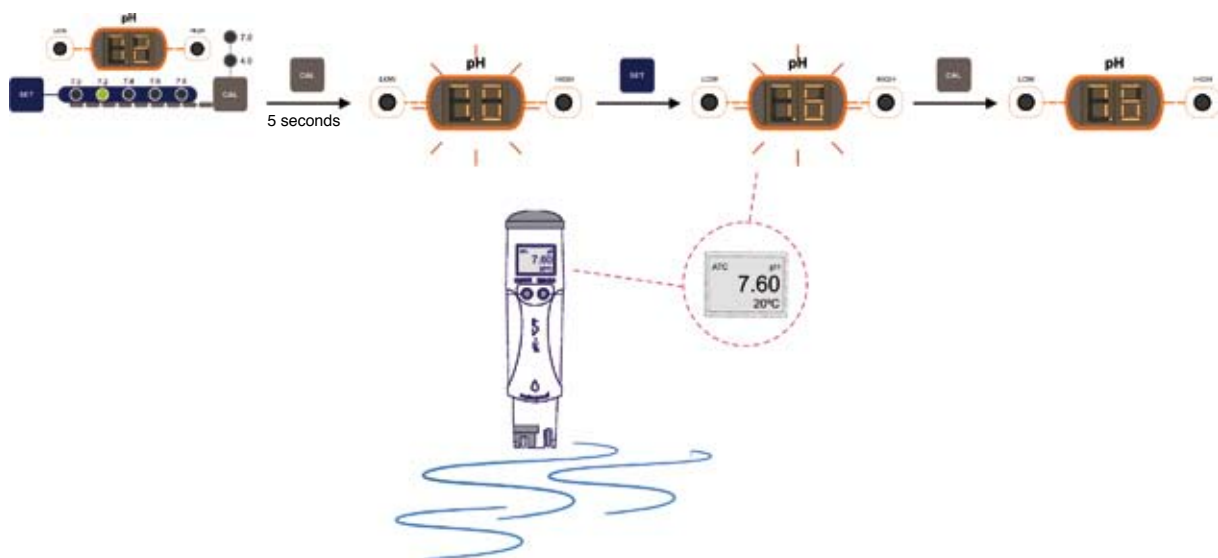

8.2.2. "STANDARD" MODE

"STANDARD" MODE allows the precise calibration of the pH-sensor using two calibration solutions of pH 7.0 and 4.0, however this method requires that the pH-sensor is removed from the installation.

PROCEDURE:

IMPORTANT: before closing the by-pass valves, stop system from control panel as described in section 7.7.1.

1. Extract the pH-sensor from the holder and wash it with abundant tap water.

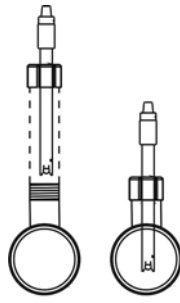

2. Press the “**CAL**” [18] key until the equipment beeps. Without releasing the key, press “**SET**” [24] for a few seconds until the pH screen displays a blinking “7.0”. The calibration light “7.0” [17] will remain on.

3. Gently shake the sensor to remove any possible drops of water and insert in the standard pH=7.0 solution (green). Gently shake for a few seconds and press “**CAL**” [18]. Once stabilised, the screen [15] will display a blinking “4.0”. The calibration light “4.0” will remain on [17].

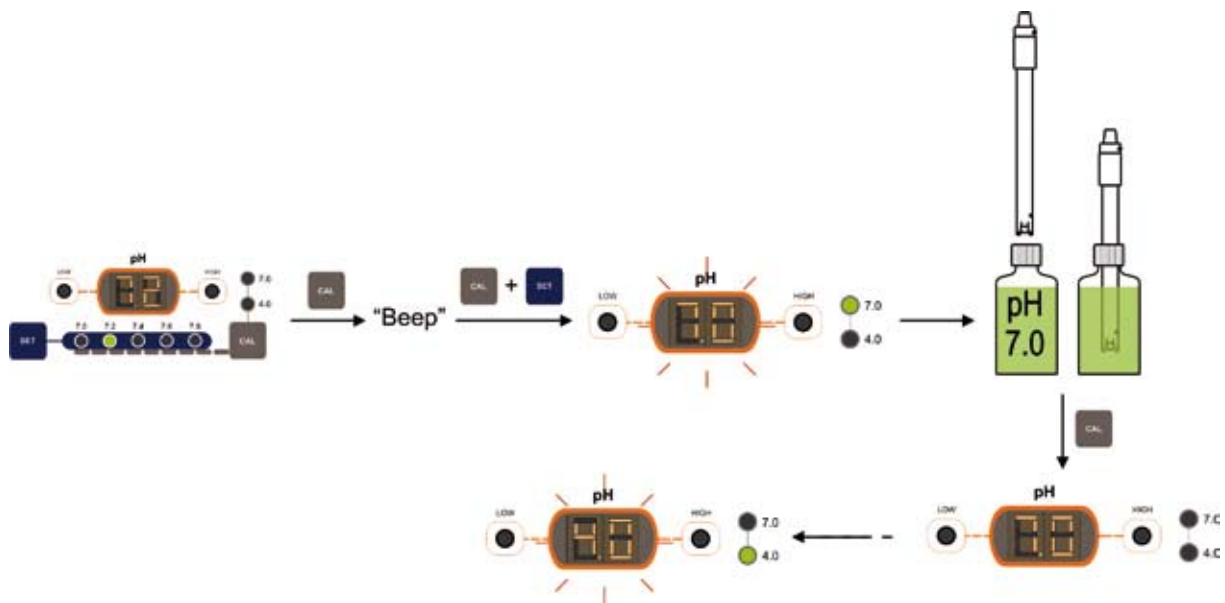

4. Remove the sensor from the calibration solution and rinse it with abundant tap water.

5. Shake the sensor smoothly so that any drops of water that may be adhered to the plastic body are removed and introduce it in the calibration solution pH=4.0 (red colour). Shake smoothly for a few seconds and press “**CAL**” [18] key. Once the reading has stabilised, the pH-controller will automatically leave the calibration mode and will be operative.

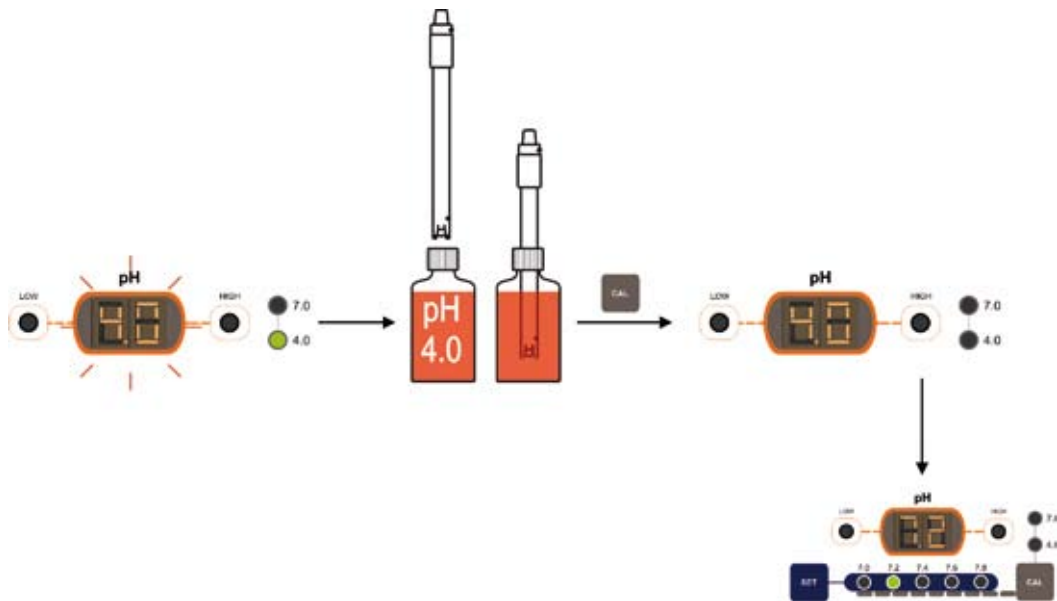

ERROR MESSAGES:



If the calibration process is interrupted for whatever reason, the pH-controller will automatically leave the calibration mode if the intervention of the user is not detected in a few seconds. In this case, “**E1**” indication in the display [15] will appear.



If the pH value during the calibration process is very different from the expected one, (e.g., defective sensor, etc.), display [15] will indicate “**E2**”, not allowing calibration.

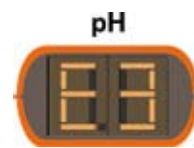

If the pH measure is unstable during the calibration process, code “**E3**” will appear in display [15]. In addition, the pH-sensor calibration will not be allowed.

8.3. CALIBRATION OF THE ORP SENSOR

The calibration frequency of the controller will be determined in each particular application. Nevertheless, we recommend making it at least, once a month during the use period of the pool. The ORP controller has an automatic calibration system for the ORP sensors based on the utilisation of a 470 mV reference solution.

PROCEDURE:

IMPORTANT: before closing the by-pass valves, stop system from control panel as described in section 7.7.1.

1. Extract the ORP sensor from the holder and wash it with abundant tap water.

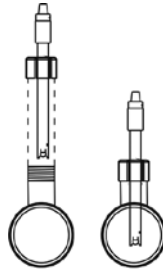

2. Press “**CAL**” [22] key for a few seconds, until the ORP display [20] blinks and indicates “470”.

3. Shake the sensor smoothly so that any water drops that may be adhered to the plastic body are removed and introduce it to the calibration solution (470 mV). Shake smoothly for a few seconds and press “**CAL**” [22] key. If the process has concluded satisfactorily, a long “beep” will be listened and the controller will be calibrated and ready to operate.

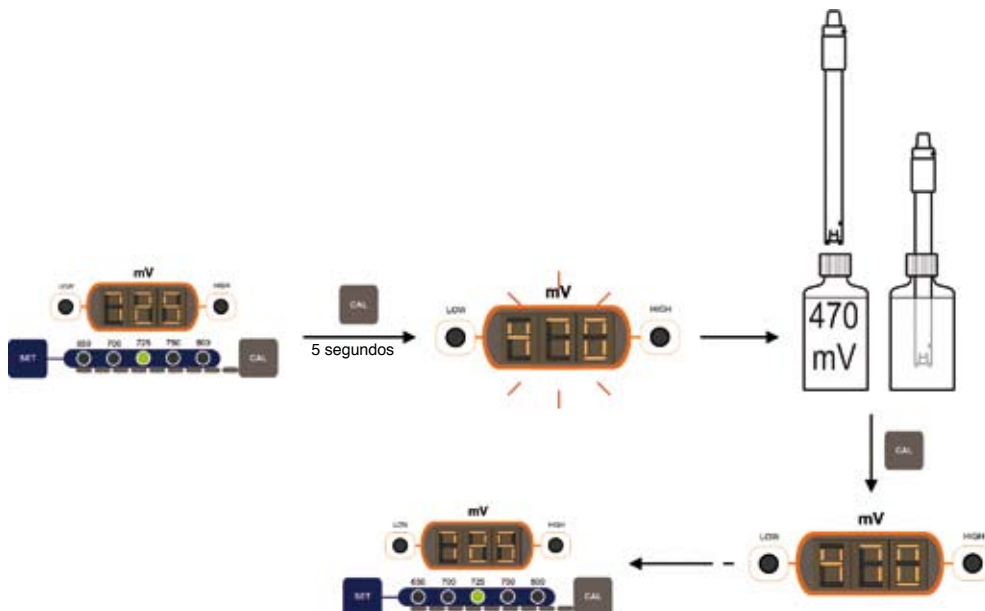

ERROR MESSAGES:



If the calibration process is interrupted for whatever reason, the ORP controller will automatically leave the calibration mode if the intervention of the user is not detected in a few seconds. In this case, “E1” indication in display [20] will appear.



If the ORP value during the calibration process is very different from the expected one, (e.g., defective sensor, etc.), display [20] will indicate “E2”, not allowing calibration.



If the ORP measure is unstable during the calibration process, code “E3” will appear in display [20]. In addition, the sensor calibration will not be allowed.

8.4. MAINTENANCE OF THE PH/ORP SENSORS

1. Ensure that the sensor membrane remains moist at all times.
2. If the sensor is not going to be used for a long period, keep it submerged in a conservation solution at pH=4.0.
3. To clean the sensor of possible dirt, avoid the use of abrasive materials that can scratch the sensor surface.
4. **The pH/ORP sensors are a consumable part, so it must be replaced periodically.**

9. Troubleshooting

PROBLEM	SOLUTION
<p>Production indicator always indicates “0” at all production levels.</p>	<p>Check electrodes. Verify connections between power supply and the electrolysis cell. Check salt concentration</p>
<p>The power supply is not turned on</p>	<p>Check the system is properly connected to 230 V/50-60 Hz in the command box of the pump. Check the state of the fuse located on the bottom of the power supply.</p>
<p>Free chlorine levels in the water are very low</p>	<p>Check that the system is producing chlorine in pool jets. Verify that the water chemicals parameters (pH, combined chlorine, isocyanuric acid, etc.) are correct. Increase filtering time. Add chlorine stabilizer (cyanuric acid) until a concentration of 25 – 30 g/m³ is achieved.</p>
<p>pH/ORP controller always shows extreme values, or readings are unstable.</p>	<p>The cable of the pH/ORP sensor is damaged. Clean the contacts or replace the cable. The pH/ORP sensor has an air bubble in the membrane area. Hold the sensor in vertical position. Shake it lightly until the bubble moves up. Sensor fault. The connection cable is too long or it is too near to sources of electrical interference (motors, etc.). Replace the sensor. Locate the unit nearer to the sensor.</p>

PROBLEM	SOLUTION
<p>Impossible calibration of the pH/ORP sensor</p>	<p>Contaminated or expired calibration solution. Blocked sensor membrane. Check the membrane is not damaged. Clean the sensor with diluted acid in water, shaking it lightly. Sensor fault. Replace the sensor.</p>
<p>Slow response of the pH/ORP sensor</p>	<p>Sensor electrostatically charged. During the calibration phase, the sensors should not be dried with paper or cloth. Clean it exclusively with water and shake it lightly. Insufficient renovation of the analyzed water (no flow through the sample point). Ensure that the tip of the sensor is submerged in the water at the sample point, and that no air bubbles are present.</p>

10. “DO AND DO NOT” table

	DO	DO NOT
Transport and warehouse	<p>Verify the state of the packaging and accompanying information about stacking.</p> <p>Always transport inside the box.</p>	<p>Do not leave the box outdoors or in very humid warehouses.</p>
Installation	<p>Assembly or manipulation must be done by qualified staff, and always according to the current rules of accident prevention and electrical installations.</p> <p>Electrical connections must be strong in order to avoid false contacts and overheating.</p> <p>Install the unit in a well-ventilated place and try to protect ventilation holes from any element which can block it.</p>	<p>The AstralPool Chlore Elite electrolysis systems work 230 V AC / 50 Hz. Do not change the power supply to operate with another voltage.</p> <p>Do not place the unit near inflammable materials.</p> <p>The AstralPool Chlore Elite electrolysis systems are provided with an IP24 protection level. They must not be installed in places that can be flooded.</p>
Start-up	<p>Verify that the other equipments installed are compatible with salty water.</p> <p>Use only the spares supplied by AstralPool.</p>	<p>Do not use salt with additives (iodized salt).</p> <p>Do not installation or replacement of any component without turning off the power supply.</p>
Operation	<p>Verify that the pH and ORP sensors are always submerged, even when the recirculation pump is off.</p> <p>Periodic manual controls of the chlorine, pH and salinity levels, adjusting them if necessary.</p>	<p>Do not operate at pH higher than 7.6.</p> <p>Do not scrape or sweep the cell or the electrodes.</p> <p>Do not operate for a long time at salinities lower than 3 g./l.</p> <p>Regular use of copper based algaecides, because its deposition can damage the sensors.</p>

We reserve the right to change all or some of the characteristics of our products or also the content of this document without notice.