



LumiPlus FlexiSlim projector

The LumiPlus FlexiSlim projector is an underwater projector for installation at surface level. It is fitted in two easy steps. The spotlight is selected first of all and then the faceplate. The spotlight is available in two power modes: V1 for private pools and V2 for public and hotel pools. For each power mode, there is a choice of cool white, warm white and RGB multicolor light. The multicolor versions are compatible with the ECO, TOP, wireless, LumiPlus LED app, ModBUS (Connect) and DMX controllers (see codes).

The projector is supplied with all of the fastenings required for its installation and is also compatible with the fastenings of AstralPool's old LED and halogen surface projectors.

For installation in liner pools, adapter 71234 is required.

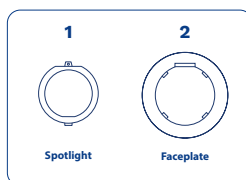

TECHNICAL SPECIFICATIONS

| | |
|---------------------------------|--|
| VOLTAGE: | 12 V AC (24 V DC in according to model) |
| FREQUENCY: | 50/60 Hz |
| SERVICE LIFE: | L70-50,000 h |
| MAX. WATER TEMPERATURE: | 40 °C |
| MAX. INSTALLATION DEPTH: | 2 m (wireless RGB projectors: max. 0.5 m) |
| MAXIMUM WATER TREATMENT VALUES: | Chlorine: 2 mg/l Bromine: 5 mg/l Salt chlorinator (NaCl): 6 g/l Pool water pH: 7.2 and 7.6 |
| CABLE | 2.5 m. H07RN-F 2 x 1 mm ² Cables from 5 to 30 meters long are available (see codes). |
| MATERIALS: | Polyamide |
| COMPATIBLE ACCESSORIES/NICHES: | 71234 (adapter for liner pools) |

Spotlight

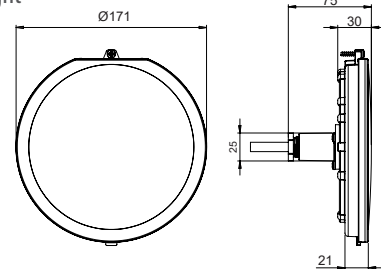



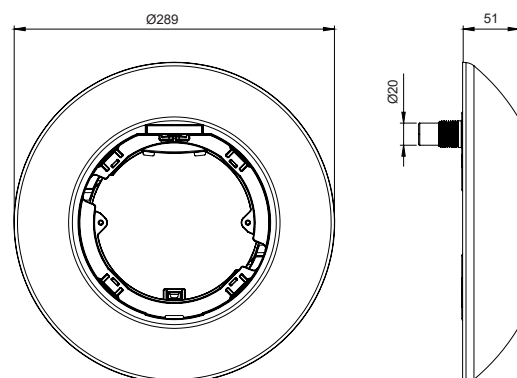





Faceplate



* measurements in mm.



| LUMIPLUS V1 | 71236 | 71200 71214 (KIT) | 71200WW | 71201 71215 (KIT) | 71201WW | 71203 | 71205 * |
|--|---|---|---|---|---|---|---|
| TYPE OF LIGHT | WHITE | WHITE | WARM WHITE | WHITE | WARM WHITE | RGB  | WIRELESS RGB |
| VOLTAGE | 24 V DC | 12 V AC | 12 V AC | 24 V DC | 24 V DC | 12 V AC | 12 V AC |
| POWER | 8,7 W | 14.5 W | 14.5 W | 14 W | 14 W | 22 W | 22 W |
| CONSUMPTION | 8,7 VA | 20 VA | 20 VA | 14 VA | 14 VA | 29 VA | 29 VA |
| LUMINOUS FLUX | 1,485 lm | 1,485 lm | 1,485 lm | 1,485 lm | 1,485 lm | 1,100 lm | 1,100 lm |
| COLOR TEMP. | 5,700 K | 5,700 K | 3,000 K | 5,700 K | 3,000 K | - | - |
| CRI > | 70 | 70 | 80 | 70 | 80 | - | - |
| LUMINOUS EFFICIENCY | 171 | 102 | 102 | 106 | 106 | 50 | 50 |
| FLUX ANGLE | 100° | 100° | 100° | 100° | 100° | 100° | 100° |
| LENS | Wide | Wide | Wide | Wide | Wide | Wide | Wide |
| THERMAL PROTECTION | Flasher | Flasher | Flasher | Flasher | Flasher | Flasher | Flasher |
| ENERGY CLASS <small>As per UE 2019/2015</small> |  |  |  |  |  |  |  |
| INSTALLATION IN SALT WATER | Yes | Yes | Yes | Yes | Yes | Yes | Yes |
| COMPATIBLE CONTROL SYSTEMS | ON/OFF | ON/OFF | ON/OFF | ON/OFF | ON/OFF | 32458, 27818, 41988, 59131, 57434 | 59125, 64633 |

* FLEXI wireless kits available:

1 Flexi spotlight + 1 Control Motion = **71206**

2 Flexi spotlights + 1 Control Motion = **71207**



Fluidra Connect compatible

PHOTOMETRIC MEASUREMENTS

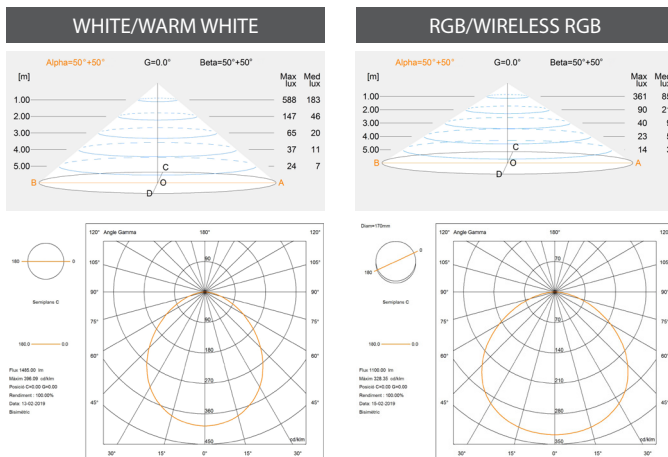



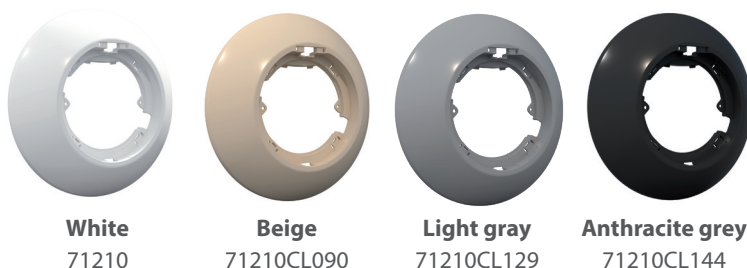



FACEPLATES



PACKAGING



| LUMIPLUS V2 | 71233 | 71233WW | 71202 | 71202WW | 71204 | 71208 |
|--|---|---|---|--|---|---|
| TYPE OF LIGHT | WHITE | WARM WHITE | WHITE | WHITE | RGB  | RGB DMX |
| VOLTAGE | 12 V AC | 12 V AC | 24 V DC | 24 V DC | 12 V AC | 12 V AC |
| POWER | 32 W | 32 W | 32 W | 32 W | 43 W | 43 W |
| CONSUMPTION | 42 VA | 42 VA | 32 VA | 32 VA | 54 VA | 54 VA |
| LUMINOUS FLUX | 4,320 lm | 4,320 lm | 4,320 lm | 4,320 lm | 2544 m | 2,544 lm |
| COLOR TEMP. | 5,700 K | 3,000 K | 5,700 K | 3,000 K | - | - |
| CRI > | 70 | 80 | 70 | 80 | - | - |
| LUMINOUS EFFICIENCY | 135 | 135 | 135 | 135 | 59.16 | 59.16 |
| FLUX ANGLE | 100° | 100° | 100° | 100° | 100° | 100° |
| LENS | Wide | Wide | Wide | Wide | Wide | Wide |
| THERMAL PROTECTION | Flasher | Flasher | Flasher | Flasher | Flasher | Flasher |
| ENERGY CLASS <small>As per UE 2019/2015</small> |  |  |  |  |  |  |
| INSTALLATION IN SALT WATER | Yes | Yes | Yes | Yes | Yes | Yes |
| COMPATIBLE CONTROL SYSTEMS | ON/OFF | ON/OFF | ON/OFF | ON/OFF | 32458, 27818, 41988, 59131, 57434 | 41107, 74099, 74100 |

 Fluidra Connect compatible

PHOTOMETRIC MEASUREMENTS

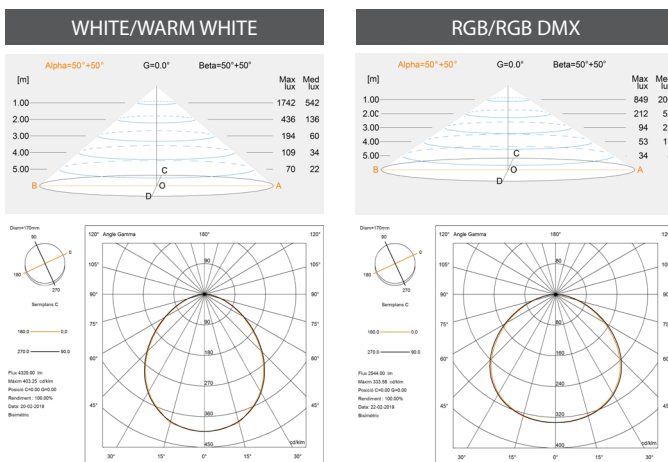

PACKAGING AND PALLETIZATION

| Code | 71200, 71200WW 71203, 71205 71233, 71233WW 71204, 71208 | 71201 71201WW | 71206 71202 71202WW | 71207 |
|---------------------------------------|--|------------------|---------------------------|-----------------|
| Single box size (mm) | 117 x 192 x 222 | | 117 x 245 x 245 | 100 x 415 x 210 |
| Volume/Single box (m ³) | 0.005 | | 0.007 | 0.008 |
| Weight/Single box (kg) | 0.73 | 0.84 | 0.89 | 1.43 |
| Units/Standard box | 5 | | 4 | 2 |
| Volume/Standard box (m ³) | 0.03 | | | |
| Weight/Standard box (kg) | 4.2 | 4.75 | 4.11 | 3.41 |
| Units/Pallet | 280 | | 224 | 64 |
| Volume/Pallet (m ³) | 2.46 | | | |
| Weight/Pallet (kg) | 250.2 | 281 | 245.16 | 124.12 |

MULTIPLE BOX
